

RADIO'S GREATEST MAGAZINE

# RADIO-CRAFT

with  
**POPULAR  
ELECTRONICS**  
★

HUGO GERNSBACK, Editor

*Read p 592  
"604"*



**SEE PAGE  
592**

JULY

**25¢**

CANADA 30¢  
1943

**OVER 100 ILLUSTRATIONS**

# FIX ANY RADIO

## Amazing New Invention

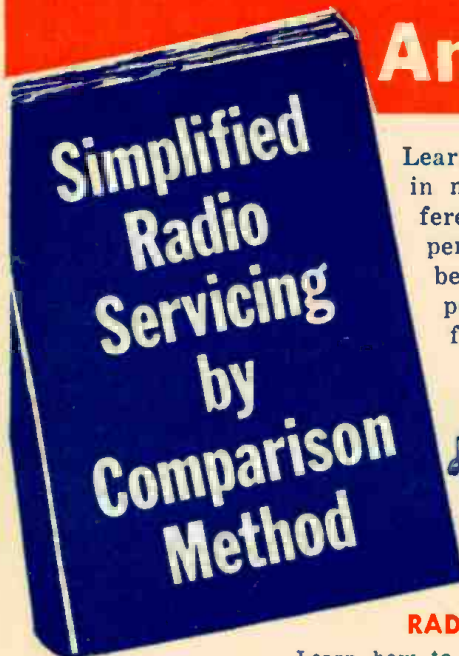

Learn radio by a simplified method. Repair radios in minutes instead of hours. Revolutionary, different Comparison technique permits you to do expert work almost immediately. Most repairs can be made without test equipment. Simple point-to-point, cross-reference, circuit suggestions locate faults quickly and easily.

**COMPLETE**  
**\$1.50**  
ONLY  
**SPECIAL OFFER**  
**READ THE DETAILS**

### FOR BEGINNERS OR EXPERTS

Understand radio principles; find any radio fault with ease. Follow the comparison tests given on 16 large trouble-shooting blueprints. Over 1,000 practical repair hints. Hundreds of simplified tests using a 5¢ resistor and a filter condenser. Covers every radio set—new and old. Introductory material for beginners and to serve as a review for experienced radio men. Also several chapters on test equipment. Presented in manual form, 112 fact pages 8½ x 11 inches. Entire plan is stark new and will help you get ahead in radio quickly.



Developed by  
M. N. Beitman,  
radio engineer,  
teacher, author,  
& serviceman.

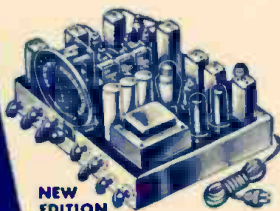

NEW EDITION

### REPAIR ANY RADIO IN MINUTES

Learn how to localize the trouble without any equipment. Make tests, measure voltage, trace the signal with a resistor, small condenser, and a crystal detector. Inject signals without any signal generator. Test parts by the new Comparison method. Test tubes without equipment. Repair any radio expertly following illustrated, simplified plans. Improve your radio servicing ability. Examine the plan without obligations—without risk. Send coupon.



### PRACTICAL USEFUL FACTS AND HINTS

Hundreds of service hints, trouble-shooting ideas, simplified tests, repair suggestions, and alignment methods are included. Benefit by the experience of others. Use the most practical method for finding the fault and making the repair. Save time on every job.

### FIX MOST SETS WITHOUT TESTERS

Follow the COMPARISON technique and repair 4 out of 5 sets without equipment. Speed up your work; locate faults quickly; make repairs efficiently. Be fair with yourself and try this new plan without obligation. Take advantage of our "no-risk" trial. Send coupon today. Use this time-saving, money-making radio servicing training for 10 days without any obligations. See how quickly you will learn helpful methods. Save time every day on every radio job. Learn new short-cuts in radio servicing. Get ahead in Radio. Repair sets for fun and profit. Prepare for higher rank and better pay in the Army. Act today.



### MONEY-BACK GUARANTEE

You must be entirely satisfied or your money will be refunded without a question. The training will more than pay for itself on the first radio job or with higher rank in the Army. Examine and use this unique plan for 10 days at our risk. Send coupon right now—use the plan this week.

## Other Practical Radio Manuals

### How to MODERNIZE RADIOS for Profit



Cash in by improving audio circuits, modernizing cabinets, adding features usually found on late model sets. Practical job-sheets with schematics and photographs make the work easy. You are told how to obtain modernization work, what to charge, and how to complete the job quickly and efficiently. Large size, 8½ x 11 in. manual is priced at only **\$1.00**

### MOST-OFTEN-NEEDED RADIO DIAGRAMS



The most popular radio diagrams available in low priced manuals. Large size: 8½ x 11 inches.  
1942 Manual, Volume 5, 204 pages...  
1941 Manual, Volume 4, 192 pages...  
1940 Manual, Volume 3, 208 pages...  
1939 Manual, Volume 2, 192 pages...  
1926-38 Manual, Volume 1, 244 pages, alignment, hints, parts lists.....  
**\$2.00** each NET  
**\$2.50**

### PRACTICAL RADIO MATHEMATICS



Introduces and explains the use of arithmetic and elementary algebra in connection with units, color code, meter scales, Ohm's Law, alternating currents, ohmmeter testing, wattage rating, series and parallel connections, capacity, inductance, mixed circuits, vacuum tubes, curves, the decibel, etc., etc., and has numerous examples. Net..... **25c**

SEE YOUR RADIO JOBBER OR SEND COUPON

# Supreme Publications

PUBLISHERS OF RADIO BOOKS, MANUALS, AND DIAGRAMS

328 South Jefferson Street

Chicago, Illinois

## "NO RISK" TRIAL ORDER COUPON

SUPREME PUBLICATIONS, 328 S. Jefferson St., Chicago, Ill.

Ship my copy of the complete Simplified Radio Servicing by COMPARISON Method manual. I must be entirely satisfied or you will refund my total remittance.

- I am enclosing \$1.50, full price. Send postpaid.  
 Send C. O. D. I will pay the mailman \$1.50 and a few cents postage  
 Also send other Supreme Publications books as listed in letter.

NAME .....

ADDRESS .....

(Use Coupon or Send Order in a Letter)

# FREE Lesson in Radio

## Here is a Partial List of Subjects This Lesson Teaches

With 31 Photos, Sketches, Radio Drawings

How superheterodyne receivers work  
How to remove tubes, tube shields  
Three reasons why Radio tubes fail  
Electrodynamic loudspeaker:

How it works  
Replacing damaged cone  
Recentering voice coil  
Remedies for open field coil  
Output transformer construction, repair  
Gang tuning condenser:  
Construction of rotor, stator  
How capacity varies  
Restraining dial cord

Straightening bent rotor plates

I.F. transformers—  
What they do, repair hints

How to locate defective soldered joints

## GETTING ACQUAINTED WITH RECEIVER SERVICING

Inside story of carbon resistors  
Paper, electrolytic, mica, trimmer condensers

How condensers become shorted, leaky  
Antenna, oscillator coil facts  
Power transformer: construction, possible troubles

Installing power cord  
Troubles of combination volume control, on-off switch

Tone controls

Dial lamp connections

Receiver servicing technique:

Checking performance

Testing tubes

Circuit disturbance test

Isolating defective stage

Locating defective part



## See For Yourself How I Train You at Home to BE A RADIO TECHNICIAN

J. E. SMITH, President  
NATIONAL RADIO INSTITUTE  
Established 28 Years

Mail the Coupon for a FREE lesson from my Radio Course. It shows how N.R.I. trains you for Radio at home in spare time. And with this Sample

Lesson I'll send my 64-page illustrated book, "WIN RICH REWARDS IN RADIO." It describes many fascinating jobs Radio offers, tells how you can train for them at home in spare time!

### More Radio Technicians and Operators Now Make \$50 a Week Than Ever Before

There's a big shortage of capable Radio Technicians and Operators because so many have joined the Army and Navy. Fixing Radios pays better now than for years. With new Radios out of production, fixing old sets, which were formerly traded in, adds greatly to the normal number of servicing jobs.

Broadcasting Stations, Aviation and Police Radio, Ship Radio and other communications branches are scrambling for Operators and Technicians to replace men who are leaving. You may never see a time again when it will be so easy to get started in this fascinating field. The Government too needs hundreds of competent civilian and enlisted Radio men and women. Radio factories, now working on government orders for radio equipment, employ trained men. And think of the NEW jobs Television, Frequency Modulation, Electronics and

other Radio developments will open after the war! This is the sort of opportunity you shouldn't pass up.

### Many Beginners Soon Make \$5, \$10 a Week Extra in Spare Time

There's probably an opportunity right in your neighborhood to make money in spare time fixing Radios. I'll give you the training that has started hundreds of N.R.I. students making \$5, \$10 a week extra within a few months after enrolling. The N.R.I. Course isn't something just prepared to take advantage of the present market for technical books and courses. It has been tried, tested, developed, perfected during the 28 years we have been teaching Radio.

#### Find Out What N.R.I. Can Do For You

MAIL COUPON NOW for FREE Sample Lesson and 64-page illustrated book. You'll see the many fascinating jobs Radio offers and how YOU can train at home. If you want to jump your pay—mail Coupon at once in an envelope or paste on a penny post!—J. E. SMITH, President, Dept. 36X, National Radio Institute, Washington 9, D. C.

#### TRAINING MEN FOR VITAL RADIO JOBS



#### \$10 a Week in Spare Time

"I repaired some Radio sets when I was on my tenth lesson. I really don't see how you can give so much for such a small amount of money. I made \$600 in a year and a half, and I have made an average of \$10 a week—just spare time." JOHN JERRY, 1337 Kalamath St., Denver, Colorado.

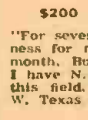

#### \$200 a Month in Own Business

"For several years I have been in business for myself making around \$200 a month. Business has steadily increased. I have N.R.I. to thank for my start in this field." ALLIE J. FROEHNER, 300 W. Texas Ave., Goose Creek, Texas.



#### N.R.I. Graduate Now Lieutenant in U. S. Army Signal Corps

"I cannot divulge any information as to my type of work, but I can say that N.R.I. training is certainly coming in mighty handy these days." (Name and address omitted for military reasons.)

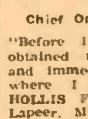

#### Chief Operator Broadcasting Station

"Before I completed your lessons, I obtained my Radio Operator's license and immediately joined Station WMPC where I am now Chief Operator." HOLLIS F. HAYES, 327 Madison St., Lapeer, Michigan.



#### Service Manager for Four Stores

"I was working in a garage when I enrolled with N.R.I. I am now Radio Service Manager for the M. . . . Furniture Co. for their four stores." JAMES E. RYAN, 119 Pebble Court, Fall River, Mass.

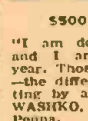

#### \$500 per Year in Spare Time

"I am doing spare time Radio work, and I am averaging around \$500 a year. Those extra dollars mean so much—the difference between just barely getting by and living comfortably." JOHN WASHKO, 97 New Cranberry, Hazleton, Penna.

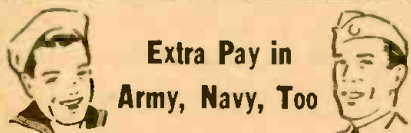

### Extra Pay in Army, Navy, Too

Men likely to go into military service, soldiers, sailors, marines, should mail the Coupon Now! Learning Radio helps Servicemen get extra rank, extra prestige, more interesting duties, MUCH HIGHER PAY. Also prepares for good Radio jobs after service ends. Over 1,700 Servicemen now enrolled.

## GOOD FOR BOTH 64 PAGE BOOK SAMPLE LESSON FREE

MR. J. E. SMITH, President, Dept. 36X  
NATIONAL RADIO INSTITUTE, Washington 9, D. C.  
Mail me FREE, without obligation, Sample Lesson and 64-page book, "Win Rich Rewards in Radio." (No Salesman will call. Write plainly.)

Age .....

Name .....

Address .....

City ..... State .....



# RADIO-CRAFT

with  
Popular Electronics

★  
HUGO GERNSBACK  
Editor-in-Chief

FRED SHUNAMAN  
Associate Editor

G. ALIQUO  
Circulation Manager



Contents JULY, 1943 Issue

VOLUME XIV -- NUMBER 10

Mailbag .....	636
Editorial: Television after the War .....	by Hugo Gernsback 581
The Radio Month in Review .....	582

## POPULAR ELECTRONICS

Popular Electronics, Part VI .....	by Raymond F. Yates 584
New Electronic Roaster Calls "Turn" on Coffee .....	by S. R. Winters 586
New Death-Ray Preserves Life .....	587
Electric Memory Machine Helps Ignitron Study .....	588
"Heatronic" Molding for Better Plastics .....	589

## WARTIME RADIO

Replacement Tubes for Battery Receivers .....	590
Plane-Wrecked Aviators Saved by "Gibson Girl" .....	592
Keep 'em Playing .....	by M. J. Edwards 593

## SOUND

New Developments in Radio Sound Effects .....	594
More Highs—More Lows, Part I .....	by Leo G. Sands 596
Novel Feature in P. A. System .....	by Arthur W. Crampton 597

## SERVICING

Voltage Analysis In Radio Service Work .....	by Jack King 598
RADIO SERVICE DATA SHEET: No. 325 Pilot Model T-133 .....	600

## RADIO TRAINING

Can Dry Cells Be Renewed? .....	603
A Method of Looking at R.F. Oscillators .....	by Milton S. Kiver 604
Cross-Modulation as a Factor in Interference, Part I .....	by Ted Powell 605
Some Soldering Pitfalls and How to Avoid Them .....	by Eric Leslie 606
Wartime R.F. Coil Design .....	by Fred Shunaman 607

## EXPERIMENTERS

Carrier Communications, Part III .....	by Werner Muller 610
A Series of Alternating Current Experiments .....	by J. H. Shay 611

## TEST INSTRUMENTS

Meterless Voltmeter Uses Electron-Ray Indicator

by Wesley Neelands 612

## DEPARTMENTS

RADIO SERVICE DATA SHEET (See Servicing) .....	600
Servicing Notes .....	602
The Listening Post .....	614
Radio Hook-ups .....	616
Radio Kinks .....	618
The Question Box .....	620
Latest Radio Apparatus .....	622
Book Reviews .....	639



Published by Radcraft Publications, Inc. Publication office: 29 Worthington Street, Springfield, Mass. Editorial and Advertising Offices: 25 West Broadway, New York City 7, Chicago Advertising Office: RADIO-CRAFT, 520 North Michigan Avenue, Chicago, Ill.

RADIO-CRAFT is published monthly, on the first of the month preceding that of date; subscription price is \$2.50 per year in U. S. (In foreign countries, 75c additional per year to cover postage; Canada, 50c additional.) Entered at the post office at Springfield as second-class matter under the act of March 3, 1879. All communications about subscriptions should be addressed to: Radio-Craft, 25 West Broadway, New York 7, N. Y.

Notice of CHANGE OF ADDRESS should reach us at least one month in advance. Be sure to give your OLD ADDRESS as well as the new, as without the old address we cannot find your name in our files.



Foreign Agents:

London—Gorringe's American News Agency, 9A Green St., Leicester Square, W. C. 2, England.

Melbourne—McGill's Agency, 179 Elizabeth St., Australia.

Dunedin—James Johnston, Ltd., New Zealand.



Text and illustrations of this magazine are copyright and must not be reproduced without permission of the copyright owners.



Copyright 1943 Radcraft Publications, Inc.

**New  
IRC  
WARTIME  
AID!**

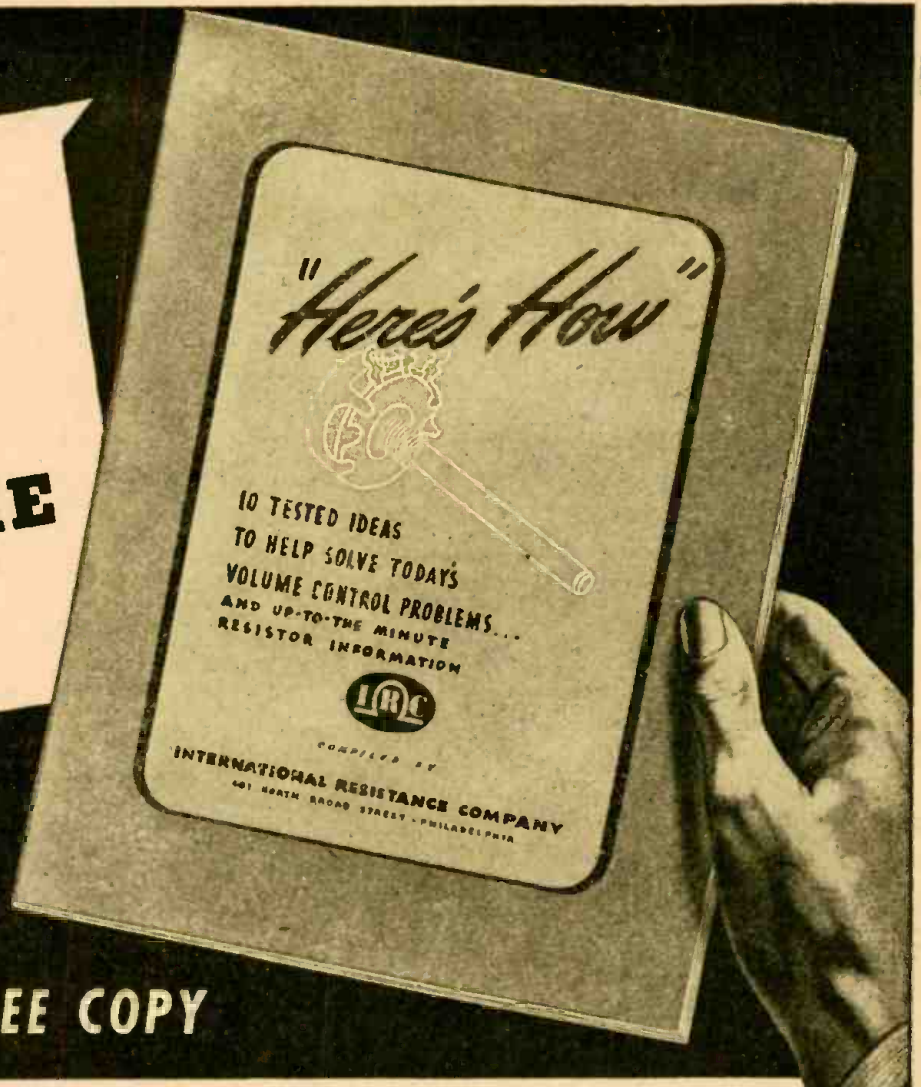

**WRITE FOR  
YOUR FREE COPY**

Remember the "Here's How" contest, recently sponsored by IRC in leading Service Papers throughout America? . . . Hundreds of Service Men sent in their suggestions on how to replace volume controls and get radio sets working satisfactorily when the controls which normally would be used were not available.

The contest judges had a tough job picking the winners and the runners-up. Piles of letters had to be read—diagrams checked. But now it's all in shape and we've put the *ten top ideas* in a booklet to help everyone in the industry faced with a volume control problem. As an added feature we've included the latest data on ½, 1 and 2-Watt Resistors (both Metallized and Wire-Wound), together with substitution information on 10-Watt Wire-Wound Resistors, now so difficult to obtain.

*These booklets are so timely and so useful to Service Men that we don't think our supply will last very long. May we suggest that you write today for your copy? No charge, of course.*



**CLIP AND MAIL THIS COUPON TODAY**

**INTERNATIONAL RESISTANCE COMPANY  
401 N. Broad Street, Philadelphia 8, Pa.**

Gentlemen:

Please send me a copy of your new "HERE'S HOW" booklet.

(Please Print Name and Address)

NAME \_\_\_\_\_

COMPANY \_\_\_\_\_

ADDRESS \_\_\_\_\_

CITY \_\_\_\_\_ STATE \_\_\_\_\_

My Regular Distributor is \_\_\_\_\_ RC

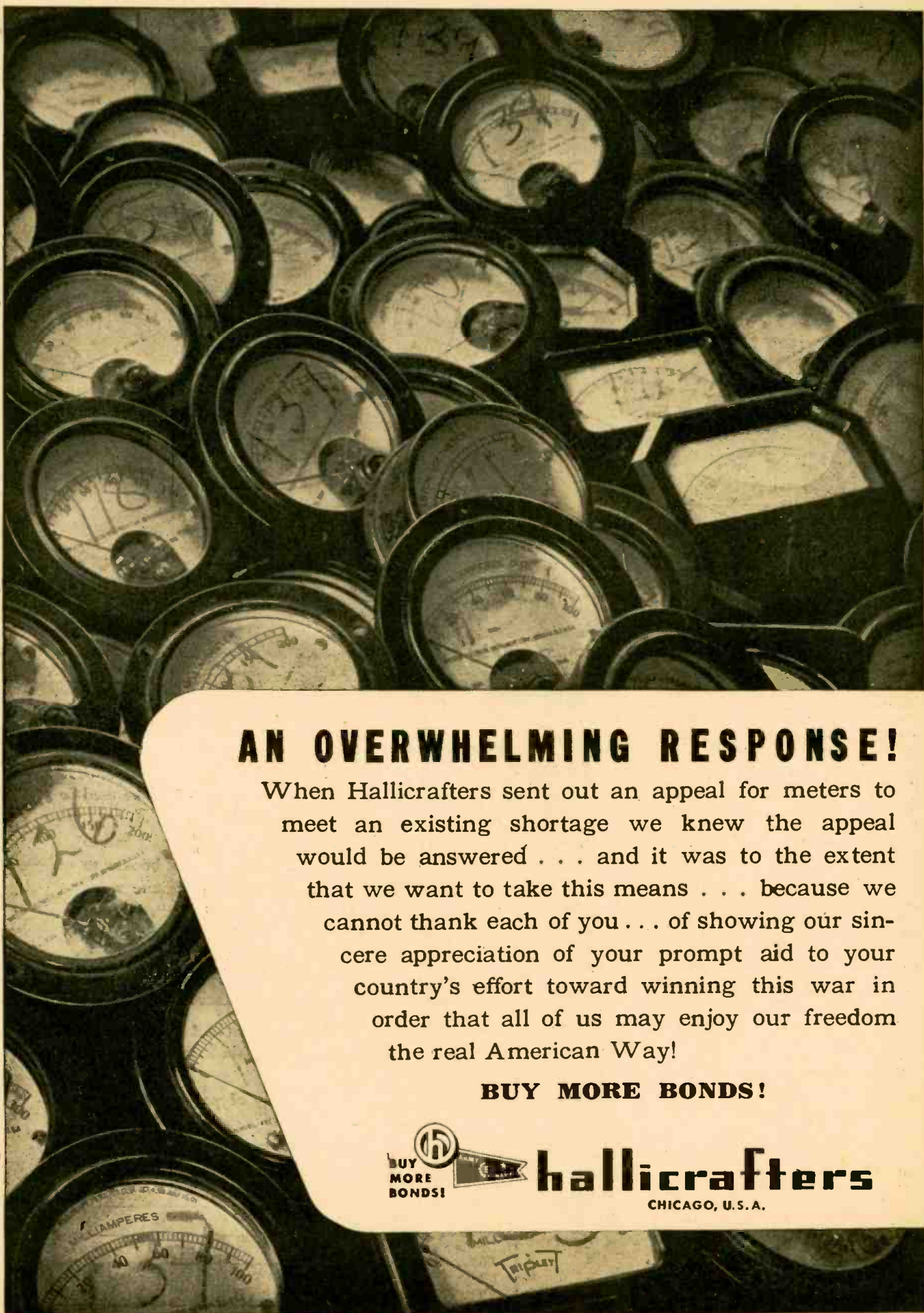

## AN OVERWHELMING RESPONSE!

When Hallicrafters sent out an appeal for meters to meet an existing shortage we knew the appeal would be answered . . . and it was to the extent that we want to take this means . . . because we cannot thank each of you . . . of showing our sincere appreciation of your prompt aid to your country's effort toward winning this war in order that all of us may enjoy our freedom the real American Way!

**BUY MORE BONDS!**



**hallicrafters**

CHICAGO, U.S.A.

# RADIO-CRAFT

with

## POPULAR ELECTRONICS

"RADIO'S GREATEST MAGAZINE"

### TELEVISION AFTER THE WAR

By the Editor — HUGO GERNSBACK

. . . . *Contrary to public opinion television is as yet not perfected, nor will it be ready for the millions immediately after the war . . . . .*

**H**AVE pointed out a number of times in these pages, that while television has made great strides in the pre-Pearl Harbor era it had not been perfected to such a degree that it was acceptable to the public at large.

While a number of television sets were sold before Pearl Harbor, these were mostly curiosity sales, plus a number that went to the radio and allied professions. There was also a limited sale of sets to stores to attract customers.

While considerably more progress has been made since Pearl Harbor, we should not mislead ourselves and jump to the conclusion that television is now fully acceptable to the public, the same as was radio in the old crystal days during the early twenties.

I have gone to great pains to point out repeatedly that millions became interested in radio in the twenties for the simple reason that for a few dollars you could buy a crystal set with a good pair of phones, or build a sensitive one-tube "blooper" and receive—at least with the latter—stations hundreds of miles away.

The situation in television is totally different for the following reasons:

1—Before we can have television for the millions, we must have many hundreds of transmitters, because television signals must go via ultra-short waves on six meters and below. The signals from a given station will not reach more than approximately twenty-five miles for best reception. This means that with some exceptions there will be no long distance television transmission, but it will be confined to local reception. This in turn means erection of hundreds, if not thousands, of television transmitters in order to give continental United States uniform television reception.

2—Radio became popular overnight, as I pointed out above, because for less than ten dollars you could build yourself a good crystal or one-tube set for easy reception. Manufactured sets—and good ones at that—sold for about twenty-five dollars. The situation in television is entirely different in that it will be impossible for the public to buy a television set for twenty-five dollars, or even fifty dollars, for a long time to come. That means considerably less sets will be sold and consequently prospective television broadcasters will be loath to invest huge sums in the erection of transmitters because they know, that for years, they will not reach a very large "viewing" audience, and therefore the commercial end of the business will not be very productive.

Television, as we know it at present, revolves around the cathode-ray tube. Now these tubes are expensive and while it is conceivable that in mass production the price will come down, it will be many years before you will be able to purchase a cathode-ray tube for, let us say, \$2.00. Unfortunately all the rest of the radio components that go with television sets come rather high, as in order to get good reception—not only of sight but of sound as well—we require at present a minimum of 17 vacuum tubes.

From this it will be seen that in the present state of the art, it will be impossible to manufacture a television set for let us say \$50, which is a popular price that would attract millions of buyers. It is conceivable that if the country remains prosperous and if a television set can be manufactured for \$150 or thereabouts, the receivers can be sold on the installment plan and a large amount of customers can thus be secured. But again this will be a matter of years, and in the writer's opinion the penetration of television sets into the average American's home will be several years slower than with the rapid penetration of the early radio sets in the twenties.

This trouble could be overcome—at least for a transition period of several years—in my opinion, if the recommendation which I made in the October 1936 issue of *Shortwave-Craft*, would be adopted by the television receiver manufacturers. I refer to a television set which I termed "Television-Spectacles." You wear a pair of spectacles, which have a twin tube television receiver built right on an eye-glass frame. This would mean having a miniature cathode-ray tube which can be built at a low price. It would even give you stereoscopic seeing on account of the twin tubes, which would also give better images. To be sure, the images received are small, but they need not be large because they are close up to your eyes. Indeed they will be sharper in this manner. Therefore, all you require is to put on television eye glasses and with an accompanying radio set on the table you will see and hear at the same time.

As I mentioned in the March 1938 issue of *Radio-Craft*, it is even possible to build the sound radio receiver on the same frame which holds the television set. Resting on the bony part of your nose, molecular vibrations may transmit sound to the eardrum in a most realistic fashion. Even if molecular sound transmission is not perfected for some years to come, a miniature but powerful telephone receiver will transmit the sound through the bony part of the nose to your eardrums. This is not a dream either, because I realized this many years ago in a patented instrument which I invented in 1927, "The Osophone." This, incidentally was the forerunner of all present bone-sound conducting hearing instruments.

The television-spectacles receiver would be cheap to manufacture and would overcome one of the greatest difficulties that television manufacturers have to cope with today—and that is the possibility of using the receiver in broad daylight. At the present time this is almost impossible because in a bright sun-lit room it is most difficult to see television images unless a large amount of power is used, which greatly increases the cost of the television receiver.

That difficulty is not present with the television-spectacle receiver because the eyes can be shaded by funnel-shaped blinders, which shut out all outside light and consequently the power of the miniature cathode-ray tube can be relatively low.

## A Digest of News Events of Interest to the Radio Craftsman

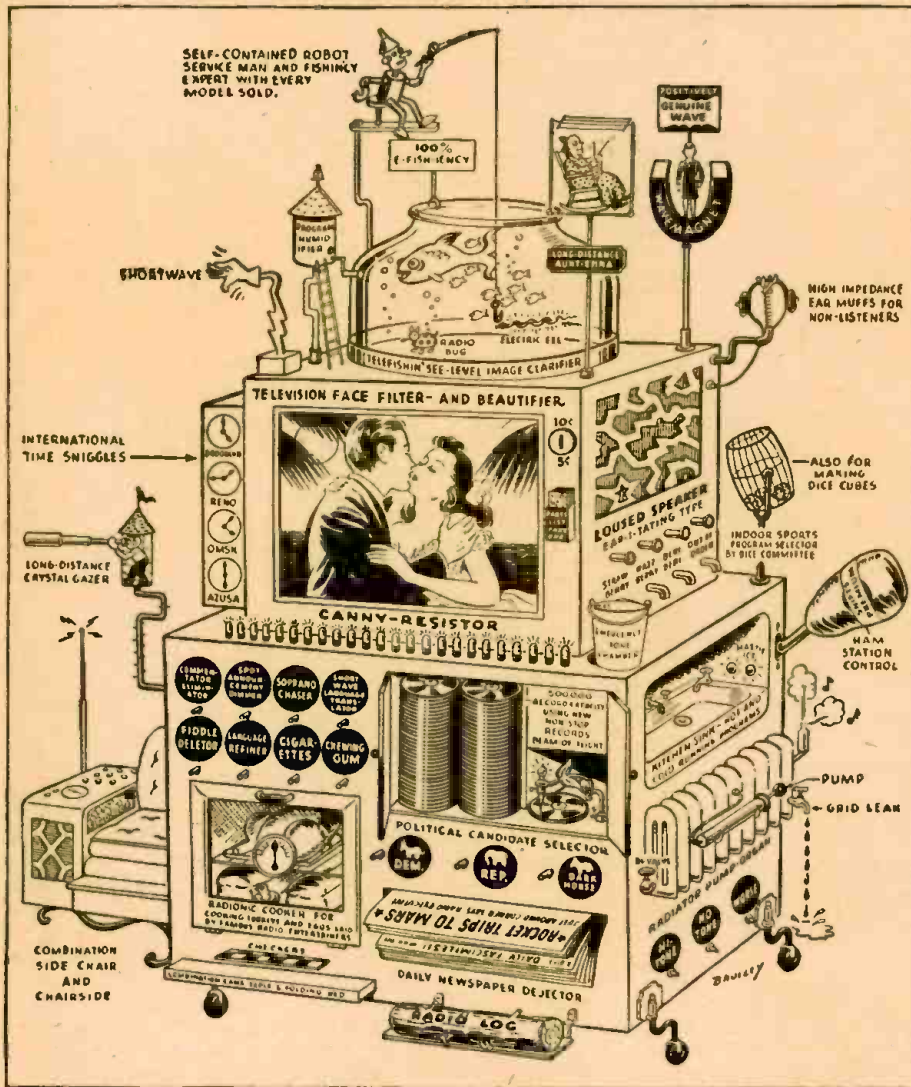

This advance design of the Great Christopher model, (priced at \$14.92 in honor of the discovery of America by Columbus) was circulated last month by Zenith Radio Co., as a mild protest against fantastic reports of future receiver developments by radio executives and others. One dealer, it is stated, failed to see the joke and rushed in his check for a number of the "new models."

### I.R.E. MAKES PROPOSAL FOR BROAD RADIO PLAN

Encouraging progress toward the creation of a broad radio technical planning association for post-war radio and electronics was reported by the Institute of Radio Engineers last month, following a meeting between representatives of the Institute and of the Radio Manufacturers Association.

Originally the formation of such a radio technical planning agency was proposed by James L. Fly, chairman of the FCC, in an address to the Institute last December. The importance of studies of radio problems prior to the formulation of regulations and the initiation of large-scale post-war production was also stressed by another member of the Commission, Commander T. A. Craven.

The Board of Directors of the Institute considered the matter, and at a meeting held May 5, 1943, issued a preliminary proposal, calling for a broad and democratic agency to handle the radio and electronic problems of the post-war world.

The new association would carry out the technical planning needed to build up a healthy post-war radio industry which will serve the public by speedily placing the new radio arts on a sound engineering basis, and by stimulating post-war radio services as

contributing to employment and prosperity. All branches of radio, such as broadcasting, television, communication, facsimile, are to be studied. Proposals for solving their technical problems are to be submitted and methods for introducing new radio developments recommended.

The association would be sponsored by interested engineering societies, industrial and broadcasting associations, and the Government. In the opinion of the Institute, the success of the plan depends greatly on a broad and democratic representation on the agency of all organizations having a major interest in the project, and in democratic procedure, particularly including appropriate methods of selecting all officials and members of the active technical Panels, and the setting of a stated tenure of office for these workers.

A special committee under the chairmanship of Haraden Pratt, past President of the Institute, has been entrusted with drafting the details of the plan and the organization of sponsor bodies, to the end that the association will be representative of a broad cross-section of the entire radio industry, including all points of view and providing a forum before which problems can be dealt with in all their aspects.

### TWO ANTI-AXIS STATIONS CONSTRUCTED IN AFRICA

From bases on the west coast of Africa, American made radio has launched a new offensive against the Axis, with two new 50-kilowatt stations spearheading the propaganda attack, according to information received last month by the International Department of the RCA Victor Division of Radio Corporation of America, which supplied and is installing the stations.

The Radio Station of the Belgian Government, speaking through its powerful new 50,000 watt RCA transmitter, is now on the air daily from Leopoldville in the heart of Belgium's African empire. Its broadcasts are beamed primarily at Belgium, and it has set as its first task the bringing of the true picture of the progress of the war to Belgians under the Axis heel.

Across the Congo River from Leopoldville, in Brazzaville, French Equatorial Africa, the antennas of another transmitter are rising.

Brazzaville has long been known as the African center of Fighting French resistance from the time of the fall of France to the fall of Tunis. Opposition to Axis influences in Algeria was organized and carried out from there. It was the economic and moral base of the bold French army under LeClerc, which struck north at the flank of the German and Italian forces, harrying them while first the British, then the Americans, attacked from east and west.

"The Voice of Free France," a 50,000 watt radio station that will carry Fighting French news to France and all parts of French colonial possessions from French Equatorial Africa, is now nearing completion and will soon join the United Nations network in its propaganda war against the Axis.

The influence of this new French capital will be greatly enhanced by the acquisition of this most modern development in the transmitting art.

The "Radiodiffusion Nationale Belge" and "La Voix de la France Libre" will speak to their own people in their own tongues and penetrate all corners of their homelands and their overseas domains with news, music, drama, and inspiration. Its mission was expressed by the Belgian station on its inaugural program when it declared:

"Our broadcasts are bombing missions. Our radio bombs carry the truth and the truth is explosive, too."

Although details of the project and the problems and difficulties encountered in assembling, transporting and erecting the transmitter cannot be revealed, the accomplishments are significant of this collaboration. The equipment of the Leopoldville transmitter was first to arrive. One month after it had reached the Congo port, the staff of the Leopoldville station, assisted by an RCA installation engineer, had the transmitter in operation—in just half the time normally required.

The new west African stations represent a new stage in the war of radio. They are ultra modern in every detail of their equipment. Tropical temperature and humidity, two of radio's natural enemies, are counter-attacked by a suitable choice of insulating and impregnation materials and air-conditioning.

These two additions to the United Nations network will strongly support the stations in England, the United States and South America already reaching the seething underground forces in Axis occupied countries. They have further assignments in the war of communications that include the relaying of news from various war theatres across the Atlantic.



## MANILA LISTENERS TUNE TO AMERICAN SHORTWAVE

Philippine short-wave listeners are still tuning their radios to Treasure Island and other American and United Nations high-frequency broadcast stations. More than 2,000 such listening posts exist in the city of Manila alone, the Japanese admitted last month in a broadcast picked up by the FBI. Discovery would mean the severest penalties, of course, but the threat of punishment has not deterred the Philippine people from listening to the United Nations transmitters.

The Japanese set a date last July for the registration of all radios in Manila. Failure to register meant confiscation of the apparatus and other penalties. A week later a list of heavy penalties for listening to foreign short-wave was announced. The registration had to be postponed several times, and the broadcast referred to announced another positively last date—June 30—as the latest moment for registration of all radio receivers in the Manila area.

Registration was to be followed by "re-conditioning" of the New Order type—removal of the short wave coils and soldering of the wave-change switch to make it immovable. Radios so treated can receive only the local broadcast stations, which devote themselves to Japanese propaganda almost to the exclusion of other features.

## AMATEUR LICENSES GOOD FOR THREE MORE YEARS

All amateur radio operator's licenses which expired after December 7, 1941, have been automatically renewed for a period of three years, according to a statement made last month by the Federal Communications Commission.

The FCC policy has been to encourage the renewal of amateur licenses, but a number of factors have worked against this. Probably no other group in the United States has contributed so large a proportion of their numbers to the armed services. Many of these men are in remote places, at a disadvantage in corresponding with government departments, in receiving and returning application forms. At the FCC end as well, war work tends to slow down the normal peacetime activities, with the result that the blanket extension was found to be the most efficient and all-around satisfactory method of handling the situation.

American "hams" perform many valuable services for the country in times of peace as well as war, so any action tending to keep them on the books and to facilitate their resumption of activity after the war is considered decidedly "in the public interest."

## NEW WESTINGHOUSE PLANT HAS PERMANENT BLACKOUT

A war-production plant of a new type was opened last month by Westinghouse Radio Division. Covering more than four acres, the plant is completely and permanently blacked out, no external light penetrating the building and none from the inside getting out.

The new plant, which will be devoted to building equipment for the Army, was built along war-time lines, all specifications being made with the object of conserving critical materials. Use of lumber is estimated to have saved more than 1,920 tons of steel. "Windows" required more than an acre of pressed wood panels, for which glass may be substituted after the war.

## OVER 80,000 STUDY WAR RADIO

More than 80,000 people have received war-time radio training since October, 1940, according to a statement made last month by Paul V. McNutt, chairman of the WMC. The courses included engineering, science and management. An additional 18,000 have been enrolled in electronics courses, it is stated.

Philadelphia, where several hundred students are being prepared for the Signal Corps. The actual components, mounted on a board with the schematic, give the student a "clearer idea quicker" of the meaning of symbols. The diagram is scaled to the same size as the actual layout, and parts are placed in the same corresponding po-

Students learn to read diagrams quickly when "working from the practical to the theoretical," as on this demonstration board. The size and convenience of the schematic also aids the student in applying theory to practice.



The majority of students are enrolled in one of the three courses: "Fundamentals of Radio," "Radio and pre-Radar," or "High-Frequency Techniques." The first of these requires only a high-school education as background, and is by far the most popular. The "Radio and pre-Radar" course sets up higher entrance requirements, while the special ultra-high-frequency course is given to students who have already attained engineer status or have had three or more years of engineering work or training.

As many as 15,000 students at one time have been enrolled in the "Radio Fundamentals" course. In spite of the fact that the vast majority of them had no previous radio training or experience, a surprisingly large percentage completed the course successfully. Graduate students were entirely satisfactory in the practical work of inspection, maintenance and repair, or as candidates for advanced training, according to one of the Signal Corps officers responsible for assignments.

The number taking the simpler subjects has not been overwhelming, it was revealed. Over 2,500 students have enrolled for the most advanced high-frequency course during the past two years. More than 65 engineering colleges are teaching this subject.

The increase in the number of women entering this field is noticeable, a larger percentage having registered during the last few months than at any previous period. The type of training is suited to the new students, and departs far from the textbook methods of pre-war days.

A typical example of such new training methods is shown in the above photograph, taken in the Philco Training School at

sitions.

The student making adjustments on the actual operating circuit finds it easy to follow the diagram below as a reference. Thus schematic reading is learned rapidly and subconsciously. Similar revolutionary teaching techniques are used in other parts of the course, with the result that skilled technicians are turned out with a great saving of time, as compared with those trained by pre-war methods.

## EASE RESTRICTIONS ON METERS FOR WAR WORK

An improvement in the distribution of radio and electric meters, so vital in war industry, is envisaged as a result of amendments made last month to Limitation Order L-203 of the War Production Board.

The amendment permits manufacturers to accept without preliminary WPB approval purchase orders for less than 500 instruments which conform to standards published by the American Standards Association or to specifications of the Armed Services. Automatic approval also is given on orders for less than 500 instruments any dimension of which exceeds 3½ inches and on orders for any number of polarized vane non-jeweled instruments, the most familiar of which is the ammeter on an automobile dash board.

Instruments governed by L-203 are re-defined to exclude portable instruments which measure more than one electrical quantity. The definition thereby differentiates between "meters" administered under L-203 and "test equipment" covered by General Scheduling Order M-293.

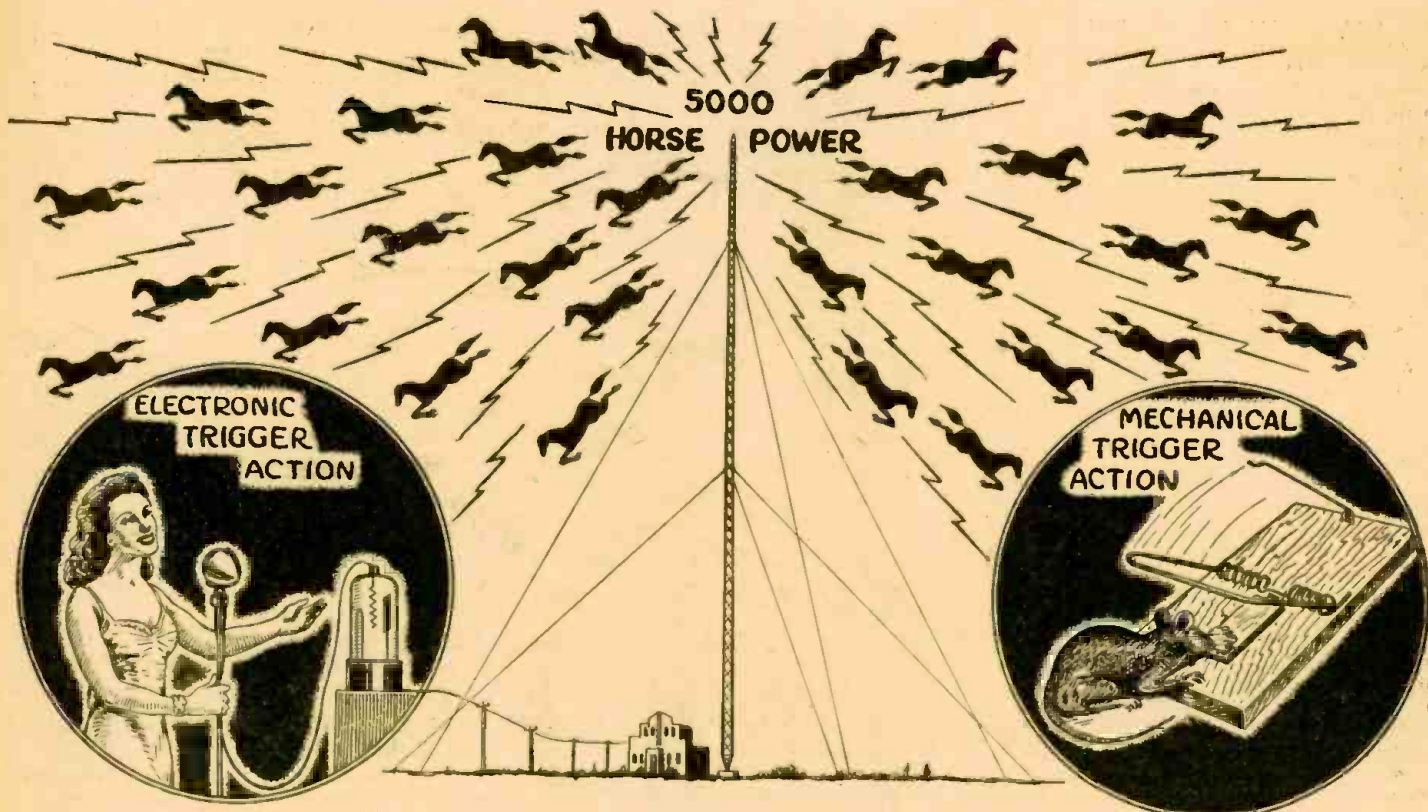

Electrical and mechanical trigger action. In each case a very small amount of energy releases or controls a comparatively immense power.

# POPULAR ELECTRONICS\*

By RAYMOND F. YATES

## PART VI

**T**HIS will be our last chapter devoted to a discussion of the thermionic and gaseous vacuum tubes. The next few installments will be devoted to the theory and use of that master electronic device, the photoelectric tube or the photo cell as it is often called. In the meantime, let us not feel that we have exhausted the subject of the vacuum tube or the gaseous tube. It is not the sort of a subject that can be exhausted so easily. Its literature is extensive and the serious student of electronics is asked to accept that which has been written in this series only as a guide and an elementary survey of the subject at large. The vacuum and gaseous tubes are so vital to the field of electronics that every student should thoroughly digest at least one of the standard and authoritative works devoted to the subject. In a very large sense, the electron tube IS ELECTRONICS.

In general, it might be said that the function of the two-element vacuum or gaseous tube is that of rectification. Such tubes exhibit a property called unilateral conductivity. By this is meant that electric current may pass with relative freedom in one direction but, within the bounds of a definite critical voltage, no current can pass in the opposite direction.

The three (or more) element vacuum tube is an amplifier of electric energy. In a very real sense, the three-element tube or triode, as it is called, is a relay in that it utilizes a very small amount of exciting energy to release a relatively large amount of local energy. This is something like a mousetrap in which the mouse, nibbling at the

cheese, supplies the tiny amount of trigger action to release enough potential energy (stored in a spring) to break his neck. (See illustration shown above.)

Assuming that the supply of electrons in a triode is relatively uniform (which is true), there are but two remaining factors to determine the number (and therefore the current) of electrons flowing between the cathode and the plate. Of course, increasing the positive charge on the plate will cause an increase in the flow of electrons and will result in an increase of plate current, something that can very easily be demonstrated with the simple test circuit diagrammed in our last installment. However, the largest changes (not necessarily increases) in the plate circuits of triode amplifiers is brought about not by increases in the plate voltage but by means of slight changes in the charge on the grid. This is the "trigger" that "sets off" large amounts of current from the plate circuit B battery.

To provide some idea of the grid-vs.-plate charge in effecting large current changes in the plate current, we find that

(for a given triode) an increase of 100 volts on the plate would increase the current 10 milliamperes. On the other hand, a 10-volt increase in the grid charge would produce the same increase in plate current. The change in grid voltage for most applications is extremely small.

In the tube circuit of Fig. 1, we note that there is an input circuit involving the filament and grid and an output circuit involving the filament and the plate. In this output circuit (sometimes called the plate circuit) we find a high-resistance relay. A low resistance relay would have the effect of short-circuiting the tube. The resistance of this unit, then, will depend in a very large measure upon the characteristics of the tube. At any rate, it will be seen that a small increase in the voltage or charge on the grid of the tube will cause a relatively large increase or decrease in the plate current and the relay can be made to function on either, depending on its type.

Although the circuits and tubes involved may take various forms according to what is required of them, this triode-relay combination is widely employed in the electronic field where large local currents are to be set free by small impulses. For instance, a photo cell in the input circuit of the triode can bring about grid charge changes that will quickly close or open the relay which we must look upon as an automatic switch.

In contemplating applications of this sort, the beginner is apt to ask the question: "What would happen if an alternating current voltage was placed upon the grid and the grid voltage was swung between zero and whatever the peak amounted to?" If

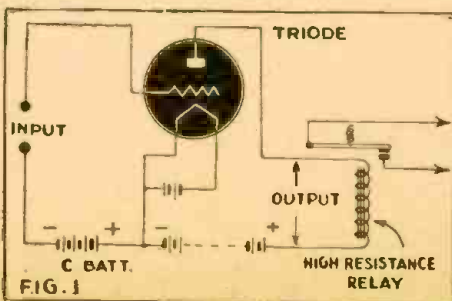

\*Application for Trade Mark Title, pending in U. S. Patent Office.

the proper triode was employed, that is, having the proper characteristics for the A.C., the amplified counterpart of the alternating current would appear in the plate circuit.

**ELECTRON-TUBE AMPLIFICATION**

Basically, we have two amplifiers. One might be called the dynamic type and the other the static type. (See Figs. 2 and 3).

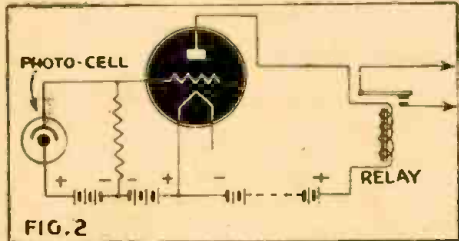

FIG. 2

The one involves a transformer in the input circuit and it is clear that no direct current, unless it is rapidly modulated (as in speech) or interrupted, will pass. The amplifier of Fig. 2, on the other hand, can be caused to act by a pure direct current from the photo-cell. In any case, the impedance or the resistance of the motivating source must be matched to the type of triode employed.

Vacuum tube amplifiers must be assembled on the basis of what they will be required to do. By the use of the proper equipment and circuits, any one of a number of small effects may be amplified. For instance, small changes of electrical capacity as represented by two separated metal plates, may be used to effect large changes in V.T. output circuits. This is the basis of electronic measuring devices.

Aside from dynamic and static (A.C. or D.C.) amplifiers, there are many types

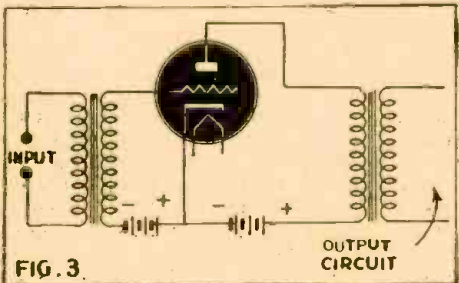

FIG. 3

coming under these general classifications. Before studying these, it will be necessary to first answer the logical question, "Is it possible to take the amplified output of one triode and put it through the input circuit of a second triode to obtain still higher amplification?" The answer is definitely in the affirmative. The multi-stage or cascaded amplifier has been used in radio for many years and certain electronic applications also call for a larger degree of amplification than can be supplied in a single triode.

With the modern vacuum tubes so eminently suited to the tasks for which they have been designed, these rarely need the

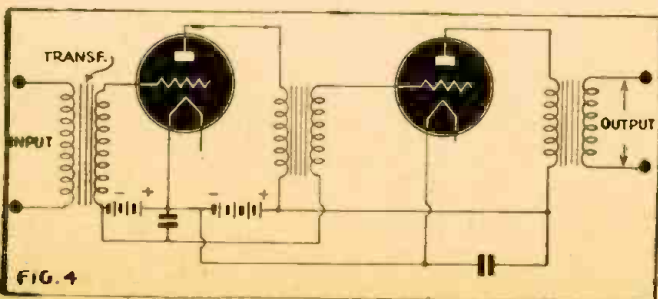

FIG. 4

use of more than two stages of amplification. Nor are such amplifiers limited only to triodes. Many different types of tubes are used for this purpose at present.

In Fig. 4, will be seen a transformer coupled amplifier involving triodes. This may be employed for musical sounds and used with low-ratio transformers to provide for amplification over a relatively wide band. It must be understood that when sound is amplified some attention must be given to the matter of frequency. Amplifiers may be designed



Sensitive milliammeter designed to work with electronic tubes. 200 microamperes applied to this relay will close contacts permitting up to 30 milliamperes, to flow in a local circuit.

for what are known as "wide bands" (multi-frequency over a wide range) or single frequencies or "narrow bands."

Another type of amplifier is indicated at Fig. 5. Here the so-called coupling between the tubes is effected by the use of resistances and capacities or condensers. Such coupling is not extremely critical in its relationship to frequency response and will provide practically distortionless amplification over wide bands of frequencies. In distortionless amplification, the wave form of the output voltage will conform closely to the wave forms of the input voltage.

Still another amplifier known as the push-pull, is illustrated in Fig. 6. Such amplifiers are employed in cases where exceptionally high output is required. Such amplifiers are practically limited to the reproduction of sound because, in the case of most industrial applications of electronics, there is no need for amplification without distortion. Here it is the magnitude of change that is sought. Where relays are employed, greater reliability will result where current changes are large.

So far we have discovered only two of the principal uses of the vacuum tube. It is known that diodes rectify and triodes

and other special forms can be made to amplify. Tubes may also be used as generators of high and low frequency alternating current; in short, they may be made to oscillate. This is equivalent to saying that they may be used to generate alternating current of any frequency between one cycle per second and many millions of

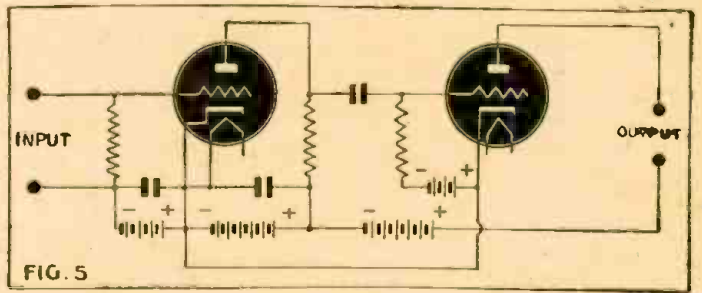

FIG. 5

cycles per second. Thus it is that the vacuum tube is used on radio transmitters for the generation of continuous waves for radio-telephony.

More important from the viewpoint of the industrial electronic field, high-frequency alternating currents are also employed in the production of heat used in hardening steel, fluxing tin on electroplated sheet steel and in the acceleration of drying in plywood manufacture. The medical profession has also taken advantage of this development in the use of short waves for the creation of deep-seated heat in body tissues. Many future applications of what we might call radio or electronic heat are indicated. Indeed a whole revolution in the art of cooking could spring from this development. Already it has been shown that crustless bread can be cooked from the inside out in place of from the inside in and that practically any food can be heated and cooked in this fashion with great success.

To generate oscillations or high-frequency current, advantage is taken of what is known as "feed-back." Part of the energy from the plate circuit of a triode is

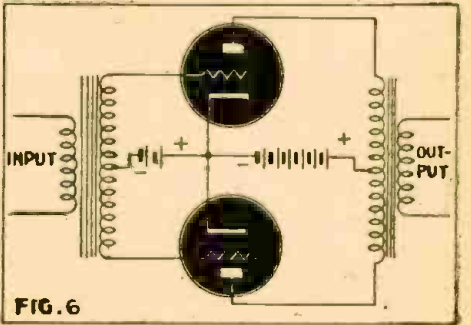

FIG. 6

fed back to the grid circuit. Thus the tube itself supplies changes in the grid charge. Power for the creation of the sustained oscillations or alternating current generated in the plate circuit of the oscillator tubes is taken from the plate battery or from what  
(Continued on page 626)

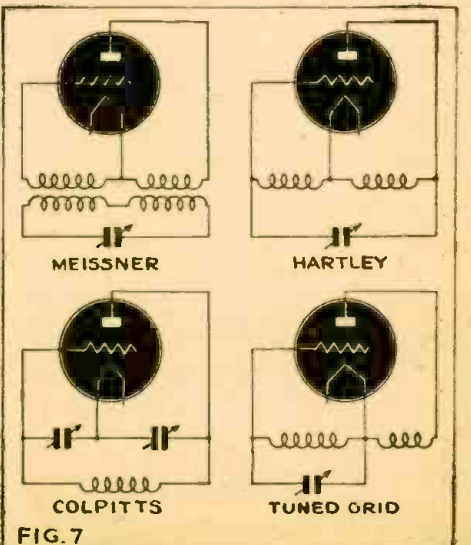
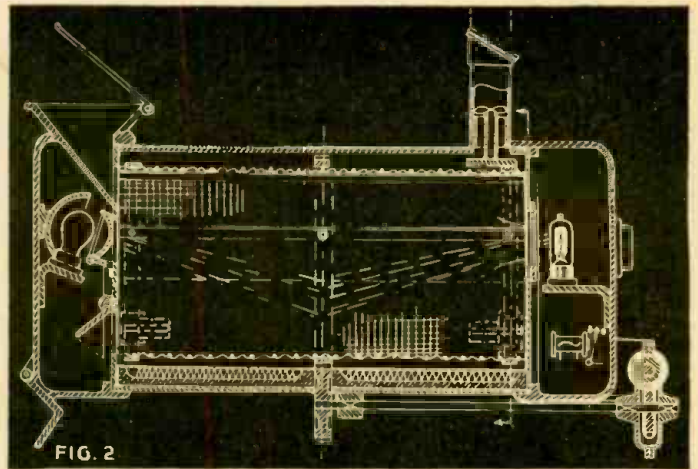
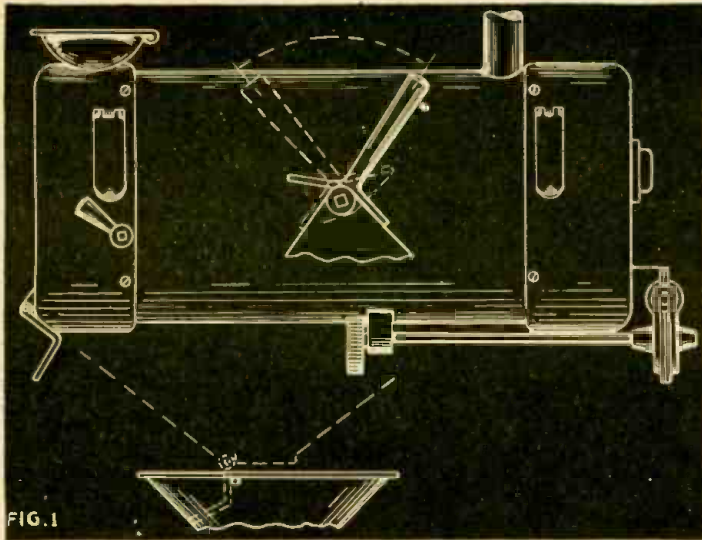

FIG. 7



Internal and external views of the electronic coffee roaster. The light-ray path from lamp to photo-electric cell may readily be seen.

# NEW ELECTRONIC ROASTER CALLS "TURN" ON COFFEE

By S. R. WINTERS

**E**LECTRONIC engineers, alert to the strange unfolding of the science of electronics in unexpected places, may soon discover tens of thousands of retail grocery stores as openings for the installation of automatic coffee roasters. A recent invention will enable grocers to buy bags of green coffee—instead of receiving large stocks already roasted from importers—and employ electronic equipment for turning off the heat of the roaster as the coffee turns from green to brown. No human eye is required to watch the roasting process, photo-electric cells performing this discerning task with scientific precision, producing the makings of the precious beverage in retail quantities of only a few pounds at a time.

Thousands of coffee and tea stores have followed the practice of roasting green coffee before the eyes of their customers—a warranty of the product's freshness—but heretofore a clerk has watched the process until the bean attained the proper brownness. If the customer bought spinach, flour, fruit, or other commodities, this particular clerk may have neglected the coffee roaster, failing to shut off the heating element or electric coil at the proper moment. The introduction of photo-electric cells dispenses with the human equation. The electric eye, with its precise discerning qualities, turns

off the roaster automatically when the green beans have browned sufficiently.

## IT'S DONE WITH PHOTO-CELLS

Capable of distinguishing between more than 2,000,000 different shades of color, it is a simple thing for the electric eye to act when the roasting coffee reaches exactly the correct degree of brownness. Its relay then disconnects the heating coil of the roaster, ringing a bell or buzzer to warn the clerk that the coffee is ready. Thus "dated" coffee becomes a product originating with the grocery store as well as with the importer, and small quantities of the freshly roasted product may be supplied instantly.

The roaster itself is a cylindrical unit, with the photo-cell in one end and the exciting lamp in the other. Between the two is a large revolving cylinder of screen material, in which the coffee is roasted, the turning of the screen agitating it during the process. The heating coils are imbedded in ceramic material in the lower half of the outer cylinder, and are covered with a sheet of copper. This spreads the heat more evenly and protects the cell from any light from the coils as they become red-hot in the roasting process.

The outer jacket, in which the roasting cylinder proper revolves, has a door at the top to admit the coffee, and one at one end of the bottom, from which the roasted grains are poured into a hopper below when roasted. The jacket is so supported by bearings—through which, incidentally, runs the shaft which turns the inner cylinder—that an arm or lever fixed to the outer shell may be used to tip the device to a sharp angle. Thus delivery of the roasted coffee is facilitated.

The inside cylinder is supported in trunnions inside the cylindrical outer jacket, and driven by an electric motor through the shaft just mentioned. The shaft terminates in a worm gear, which engages in an annular rack on the roasting cylinder, giving it a slow and steady motion. The whole roaster is shown in Fig. 1.

## THE PHOTO-CELL CIRCUIT

Analogous to the special provision of devices to prevent burglars from outwitting the effectiveness of electric-eye burglar alarms by introducing flash-lights, the inventor bars light rays from the interior of an electronic coffee roaster in this manner: A copper or other metal plate is interposed between the electric heating coil and the revolving screen, thus insuring normal behaviour of the photo-electric cell. Also located adjacent to each end of the revolving screen are two partitions to prevent the coffee from entering the chambers. In one of these partitions is a groove-slide frame, in which is a glass plate as a covering for the opening which admits light rays from the starter lamp to the photoelectric cell in the chamber. The other partition is likewise provided with a grooved slide frame, through which the light rays from the starter lamp are thrown into the cylinder-like screen through the tiny opening in one of the partitions. Just above this aperture, or small opening, is the coffee intake port, communicating with the filling hopper, to which is affixed, by hinges, a cover to protect and exclude light.

One of the caps, closing one end of the  
(Continued on page 625)

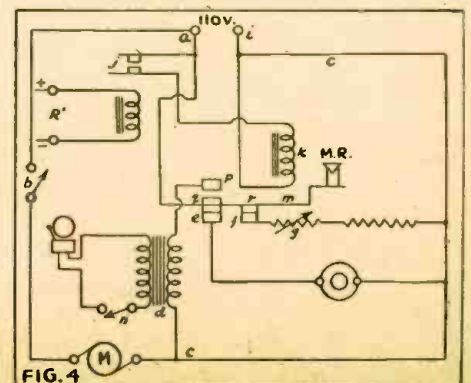
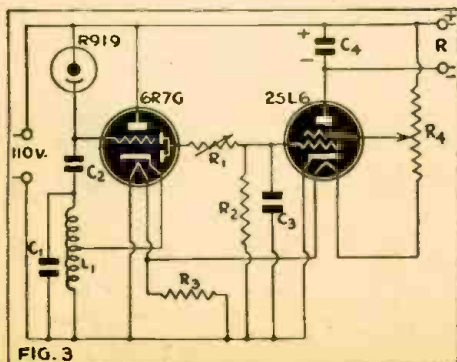



## NEW DEATH-RAY PRESERVES LIFE

*Here is another of the new applications of Electronics to the every-day world. Within a few years these germicidal lamps will be standard equipment in all schools, hospitals and public buildings. Owners of movie houses, concert halls, etc., will be compelled by law to install them. The intelligent Serviceman will be on the alert to grasp the splendid opportunities offered in the sale and installation of such equipment. Eminently fitted by mental attitude, training and experience to pioneer in the introduction of new electronic equipment, he is the logical person to handle this profitable new device.*

**E**VER since the discovery of rays or waves beyond the range of human senses, there have been rumors of a "death-ray" or wave which would destroy all life in its path. In the case of the X-rays, these stories were only too true, for the early experimenters did not know that it was necessary to take special precautions against these strong emanations. More than one of the scientists who pioneered in the field of radiology paid for it with an arm, or even his life. Given sufficient and prolonged exposure, these were death rays indeed!

Not many years ago, an English experimenter, Grindell Mathews, announced the discovery of the so-called "death-ray." His story was that his ray would—by ionization or otherwise—render the air in its path conducting. Thus an airplane could be brought down, because as soon as the ray was turned on it, its ignition system became one short-circuit. Living beings could be killed by the ray by simply sending a current of electricity along it and electrocuting them!

To the present time it is not known whether the "ray" was a fraud or an application of old principles of induction and ionization, effective over short distances but useless for long-range work, but the present war shows that it never proved effective.

It has long been known that ordinary sunlight contains rays destructive to disease-causing bacteria. An hour of bright sunlight is as effective in destroying most germs as is one minute in the heat of boiling water.

Sunshine contains many rays not visible to us. Like radio waves, these are measured by their wavelength. The unit wavelength is one ten-millionth of a millimeter, known as one Angstrom unit. Red light is in the

neighborhood of 8,000 Angstroms—violet approximately 4,000. Below this band is a much wider spectrum "of ultra-violet light" which runs down to approximately 300 Angstroms, below which point they are known as X-rays.

It was early discovered that the rays so harmful to germ life lay not in the visible spectrum, but somewhere in the ultra-violet band. Investigation showed that in that great spectrum—many times as broad as the band of visible light—certain radiations were to be found that promoted health directly, as well as those others which did so by destroying harmful life. The wavelengths just below the visible rays of violet light are those which produce suntan and Vitamin-D. When we get down to waves of about 3000 Angstroms, we begin to find those rays of light which are most harmful to bacteria. At 2600 Angstroms they reach the peak of their lethal power, and gradually drop off in deadliness till at 2000 Angstroms they are again comparatively innocuous.

The first lamps built to produce ultra-violet light broadcast their radiations over a wide band, producing some visible light, ultra-violet light both of the desired and undesired wavelengths and other radiations of widely different frequencies. These ultra-violet generators could be compared to the old spark transmitters which emitted such a broad note that they could be tuned in over a range of several hundred meters.

This type of generator was uneconomical, produced a great deal of heat and ozone—both detrimental in many applications—as well as many rays not only useless but actually detrimental. Some means of "tuning" the lamps to produce radiations of only the correct wavelength was necessary to make the device practical.

The problem of tuning was solved by the production of a type of glass which would transmit the germicidal rays, and of a light-source which dissipated little energy in the visible-light range or at longer wavelengths. It is well known that ordinary window glass passes no ultra-violet light. Special glass has been developed for nurseries and hospitals, which lets through the beneficial rays at the long-wave end of the ultra-violet spectrum. The new germicidal-lamp glass is penetrated by waves in the order of 2540 Angstroms. The new lamp, with an improved light source, concentrated 80% of its energy in the useful band, and was hailed as a practical success.

About the same time a man of the medical world, Dr. Hart of Duke University, was carrying out experiments designed to reduce the rate of post-operative infections. By a process of elimination, he became convinced that infection was due to germs in the air contacting tissues exposed by the surgeon's knife. Unless he could find a way to sterilize the air, infections would remain at a comparatively high level.

Dr. Hart, in consultation with Dr. Harvey C. Rentschler of Westinghouse—one of the men responsible for the development of the new lamp—rigged up an experimental operating room, with eight lamps in a square directly over the table. From that day, infections following operation practically disappeared, dropping from the earlier figure of 11.9% to 0.24%. As Dr. Hart had suspected, the infections had been air-borne, and the new death-ray was amply capable of taking care of the situation.

The way in which the germs meet their death was the next subject of investigation. A micro-organism considerably larger than bacteria—and presumably that much harder

(Continued on page 627)

Left—A number of Westinghouse Steelamps. The smallest is a single-ended type mounting in a screw base. The others use standard mountings. Right—Spectrograph of light from germicidal lamp. Figures are in hundreds of Angstrom units. Broader bands in upper scale are due to longer exposure.

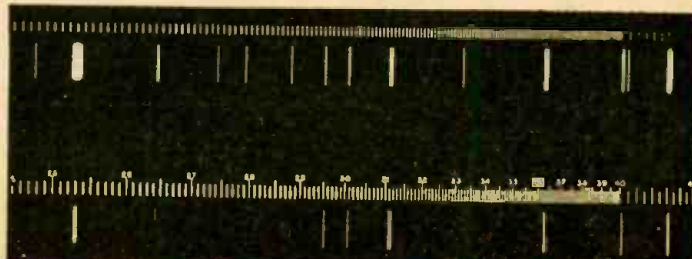
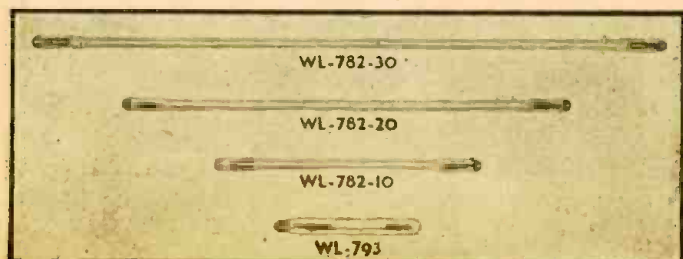

# ELECTRIC MEMORY MACHINE HELPS IGNITRON STUDY

**T**HE rapidly expanding use of Ignitrons as rectifiers in industry has brought in a new group of technical problems.

Questions of operating temperature and maximum current flow assume great importance. One of the bug-bears of the Ignitron technician is arc-back, or break-down and conduction of the gases in the tube on the supposedly non-conducting half of the cycle. The tube becomes a two-way conductor, and if voltage is not removed damage to the apparatus being supplied, as well as damage to the tube itself, may occur. Circuit breakers are used to pull an arcing tube out of circuit, but losses of time occur whenever a rectifier is rendered in-operative. For these reasons it is important that as much as possible be known about the cause and prevention of such arc-backs.

It is hard to investigate what is going on at times inside a vacuum tube. Therefore it is not surprising that not everything is known about this troublesome phenomenon. There was a certain amount of doubt—even among authorities—as to the relative importance of the ascribed causes of arcing, or even the period of the cycle when arcing was most likely to occur. A great deal of observation was necessary to establish the conditions in an Ignitron which preceded arc-back.

## A. CATHODE-RAY OBSERVER

Oscilloscopic observation is the best method of obtaining such information. The question of the best method of recording the information posed another problem. A camera could be set up in front of the

oscilloscope and run continuously. The only difficulty is that the arc-backs may be separated by many hours—or even days—if the tube is being operated under normal conditions. A tremendous waste of film would be involved in such a recording system.

What was required was a switch that would start the camera just before the arc-back took place, recording the electrical conditions prevailing in the tube before and during the arc. But these arc-backs give no warning of their approach. The first impulse that could be used to put a camera into operation would have to be supplied by the arc itself.

## DESIGN FOR A "MEMORY" MACHINE

The problem was similar to one confronting engineers who wished to study electrical conditions in the atmosphere just before a lightning stroke. This was solved by using a high-persistence cathode-ray tube, on which the trace remained for several seconds. The lightning flash was used to operate the camera, and the picture taken was of conditions immediately preceding the stroke. The slow fading of the trace on the cathode-ray tube actually gave it an electrical "memory" and allowed it to report happenings already in the past.

Building up of static voltages before a stroke of lightning is a slow process. The Ignitron goes through a complete cycle in 1/60 second. A high-persistence tube would be useless as a means of memorizing its current and voltage changes, as the trace would not fade out fast enough to make any record possible.

Tackling the problem in another way,

William Pakala, research engineer at Westinghouse, decided to make a memory machine with a quicker understanding and a shorter memory.

Going to work on a small electric motor, he removed the windings, then to each of the 147 commutator bars he attached a 0.1 mfd. condenser. The condensers were specially made to fit in the armature slots. The second terminal of each condenser was connected to a common collector ring. Two brushes were provided—one to charge the condensers from the Ignitron circuit, the second to discharge them through the circuit containing the oscilloscope. A motor was used to revolve the machine at desired speeds. Thus the cathode-ray tube recorded electrical events that had happened practically one revolution of the memory machine before.

Mr. Pakala named his device the "Memnoscope." Its memory can be shortened or lengthened by speeding up or slowing down the motor. As the length of memory is shortened, its ability to pick up detail increases correspondingly. This is because each condenser charged and discharged is like a point on a graph. By charging and discharging more in a given time, the graph points come nearer together and a smoother curve is obtained. Where reference points may be more widely spaced in time, the machine may be slowed down and its memory correspondingly lengthened.

## THE AUXILIARY EQUIPMENT

The complete circuit of the Memnoscope is shown in Fig. 1. The necessary associated apparatus is simple. A small thyatron, with a high-speed relay in its plate circuit, is connected in such a manner that an arc-back trips its grid circuit, causing the camera to go into operation. The events immediately preceding and during the arc-back are then photographed. Connections to the Memnoscope are made from the opposite sides of the rectifier from which the voltages to charge the rotating condensers are obtained. These voltages are fed into the condensers through the input brush I and out to the cathode-ray tube from the output brush O. The brush S shorts each con-

(Continued on page 627)

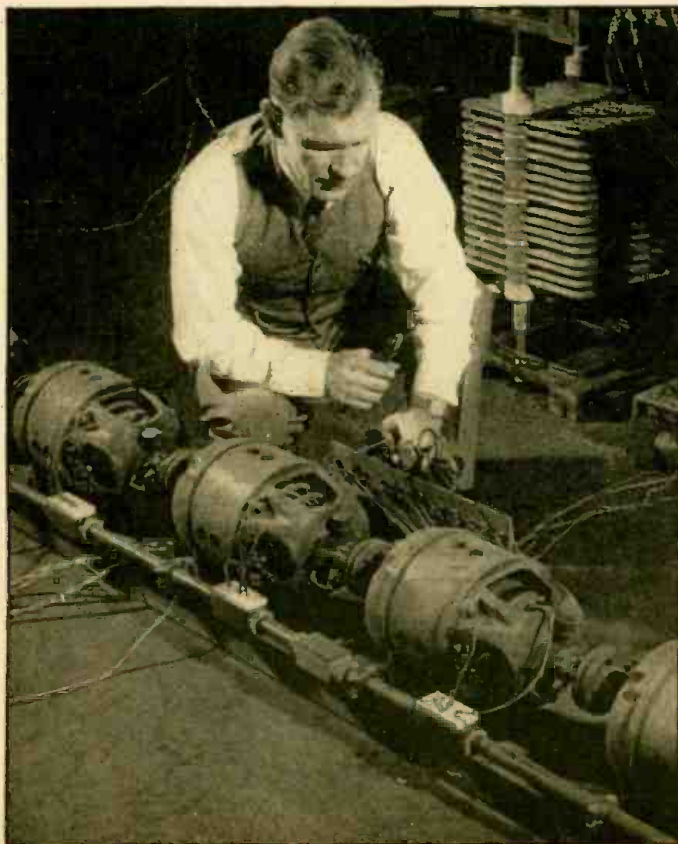

← Mr. Pakala at the speed controls of one of his latest Memnoscopes. There is no difference in appearance between the rotating condensers and the motors that run them.

Fig. 1—Schematic → of the complete circuit. The rectifier tube under inspection is at the top right corner of the diagram.

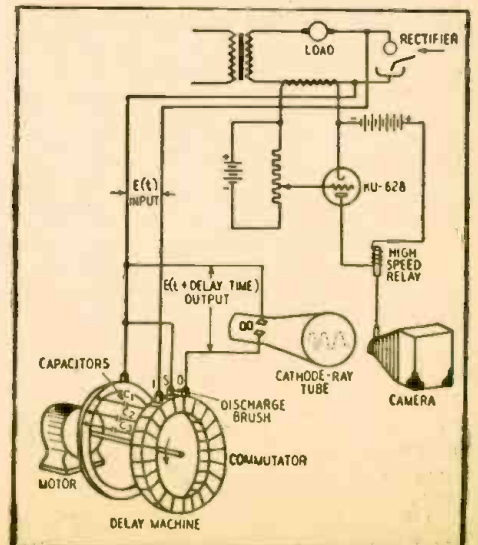

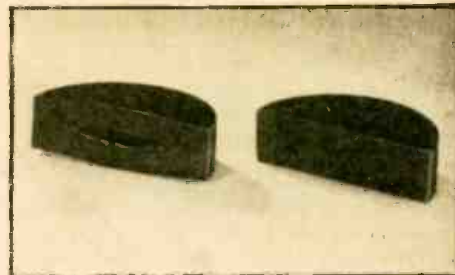
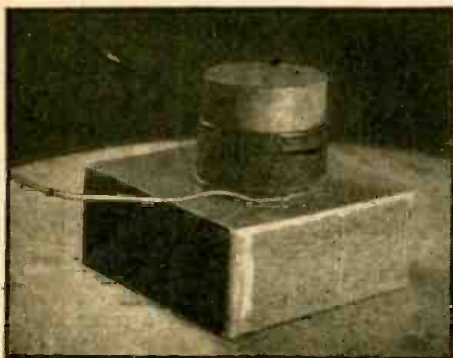

Fig. 1, at left—Preform placed between electrostatic plates ready for heating. Fig. 2, center—These two cups are molded under equal pressure. Heatronics molding produced the perfect cup. Fig. 3, at right—Advantage of Heatronics in molding thick pieces is forcibly demonstrated here.

## “Heatronic” MOLDING FOR BETTER PLASTICS

FROM the earliest days of broadcasting, it has been known that non-conductors and partial conductors heat up in a radio-frequency field. Experiments designed to use this effect began some years ago and progressed steadily up to the time when the demand for increased speed in war production led to the present great expansion of the art.

Two main methods of applying radio-frequency fields have been used—electromagnetic and electrostatic. The former held almost complete sway in the early period of radio-frequency heating. Electrostatic methods were neglected to some extent at first—though as early as 1933 an electrostatic heating unit formed the subject of a cover display on *Short Wave Craft*—but is now considered superior to induction in dealing with non-conducting masses or those with extremely high resistance.

### ELECTRONIC VS. STANDARD MOLDING

High frequency electrostatic fields have recently been used successfully for several types of heating where ordinary methods of external application have been slow and unsatisfactory. Some of these applications have been discussed in recent articles in this magazine. Possibly in none have the results been as striking as in the molding of plastics. One of the most severe limitations in the older method of molding, which depended on external heat, was the rate at which the material could be brought to the molding temperature. Most plastics in themselves are not rapid conductors of heat, and this sets a definite limit on the thickness of pieces which could successfully be molded.

This problem does not appear in electronic heating. Conduction loses its importance—the heat is generated right on the inside where it is needed. Exposed to the electrostatic field, the tug back and forth of the molecules as they are distorted by the force of the rapidly-alternating field sets up a “molecular friction” which brings the plastic quickly to the flowing point. Since the field is practically uniform throughout the mass, the heating occurs evenly all through the body, and the problem of getting heat to the center of thick sections is solved.

### FACTORS CONTROLLING EFFICIENCY

As the average radionian would expect, the rate of heating depends very largely on the materials being heated. Extremely good dielectrics, such as the polystyrene used for insulators at high frequencies, cannot be successfully or economically molded by electrostatic heating at any fre-

quencies commonly employed. Most of the other plastics have a sufficient “loss factor” to make radio-frequency commercially applicable to them.

The frequency of the heating current is important in handling non-conducting materials such as plastics. Most such materials show a higher loss factor at high frequencies than at lower ones, and there are applications of radio-frequency heating where extremely high frequencies are essential to success. Many of the common plastic molding compounds have a fairly constant heating factor over a wide range, and other factors than the loss factor of the product can be taken into account in selecting the operating frequency. One of these is the potential across the heating condenser, which drops as the frequency rises, for any given heating rate. Thus higher frequencies reduce danger of arc-overs across the electrodes.

### METHODS OF MOLDING

The problem of how to apply the heat has been met in more than one way. Molds themselves may be made of a low-loss ceramic material and the heating done in the mold itself. The powdered plastic may

be raised to the required temperature and injected into the molds in a manner similar to that used with external heating methods, with the advantage of more uniform melting and temperature.

The simplest and most effective method so far devised has been to preform the plastic material by compression, heat it to the required degree in the electrostatic field, then transfer it quickly to the mold. Such a preform between its condenser plates is seen in Fig. 1.

The immediate result is a great saving in molding time. Some pieces which had to remain in the molds for 7 minutes were completed by 1½ minutes by the Heatronic process. This item alone represents a great saving and permits a valuable intensification of production.

### ADVANTAGES OF “HEATRONICS”

Plasticity or flow properties are also greatly improved. This makes it possible to mold at lower pressures than are necessary with older methods. Fig. 2 shows two identical cups molded under pressure of 6,000 lbs. The Heatronic molded job at the right

(Continued on page 626)



This compact and easily adjusted unit supplies all the heat necessary, and supplies it only at the point where it is used. Nothing is heated but the plastic and the plates which contact it.

WPB LIMITATION ORDER A BOON TO SERVICEMEN

LIMITATION ORDER L-265 of the War Production Board — the well-known part-for-part decree — has been hailed in more than one quarter as a real contribution to war servicing.

"Legislation that benefits consumer, serviceman and jobber, while cutting red tape to the bone," is the comment of Aerovox executive Charles Golenpaul. "I like this Limitation Order L-265. It's simple. It reduces paper work to a minimum, yet safeguards the use of our strategic materials as it should. For the first time, the serviceman can really buy those replacements he needs in his work. By submitting the defective part he has removed from a radio or similar assembly, or certifying that he needs the replacement, he can walk into his jobber's and get that required part. The jobber need have no hesitancy in giving the part to the serviceman since he can replace his stock on this same part-for-part basis."

It is to be hoped that the tendency of wholesalers and jobbers to hoard merchandise will be relieved by the new order. The former situation, when servicemen could— theoretically — obtain replacement parts without a priority, while the jobber had to have a priority in order to replenish his stock led to uncertainty and a certain unwillingness to let go of parts. Now, sure of replacements, he need have no fear of selling any and everything on his shelves.

To be thoroughly effective the order requires enforcement. If too great a willingness to accept certificates instead of actual defective parts is shown, there will still be an opening for the person who tries to stock up on more critical parts to the detriment of servicing in general. Since it is the servicemen who would be most directly affected, it is their responsibility to insist on complete and thorough enforcement of the order.

REPLACING RECTIFIERS

THE best substitute I have found for a 35Z5 tube is the 50Y6. In most cases the only socket change necessary is a jumper from No. 4 to No. 8 pin, to connect the two cathodes together. This will not have to be removed if you again replace with a 35Z5.

This tube arrangement has a unique advantage over the 35Z5 hookup. In most sets the plate voltage is taken off at the No. 3 pin through a resistor, and in using the 50Y6 the plate current must first pass through the filament of the pilot bulb. Replace the blue bead bulb with a No. 47 tan bead and the pilot lamp will become a good tuning indicator.

RALPH W. KELLY,  
Bicknell, Ind.

(Mr. Kelly makes no provision for the different voltages of the two tube filaments. Apparently he finds the drop of about 10% not noticeably detrimental to the action of the receiver.—Editor)

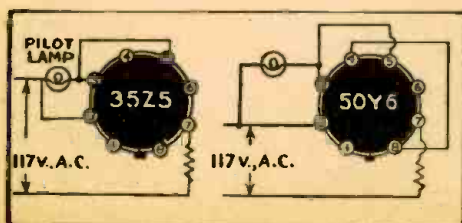

REPLACEMENT BATTERY

A TUBE replacement chart was printed in *Radio-Craft* last July. This covered all types, from the 1A5-G to the 1853. The chart was fairly satisfactory for the standard receiver types, but it was early noted that it was not detailed enough for high-voltage filament tubes and those used in battery sets.

Servicemen have attacked the problem of replacing and substituting high-voltage tubes with a great deal of enthusiasm and ingenuity. These types—chiefly used as amplifiers or rectifiers in A.C.-D.C. receivers—are very common, and it was necessary to find means of keeping radios going if—say—the 50L6 burned out and no other was to be had.

Some of these plans—printed in recent issues of *Radio-Craft*—have shown how a 35L6 may be substituted for a 50L6 by using a 60-ohm filament resistor, or a 25L6 by using shunting resistors or paralleling three 12-volt tubes and the 35-volt rectifier, making them in effect a 35-volt, 0.3-ampere tube which can be used in series with the 25L6. Necessary voltage adjustments were shown in some of these circuits. Other authors assumed that the serviceman should be able to add the correct amount of filament resistance to make up for voltage changes.

Substitution of a 43 for the 'L6 types was mentioned, and necessary changes discussed. Other changes included rewiring to use tubes of totally different characteristics. A special feature was the treatment of combination tubes. In some cases where a single tube acts as pentode I.F. amplifier and diode detector, followed by a straight audio stage, it has been found possible to replace it with a straight pentode, and change the audio tube to a diode-triode as detector-amplifier.

The 35Z5 with the burned-out pilot light section has come in for more attention than any other tube. Solutions of this problem range from constructing a shorting plug out of a pilot lamp to the apparently perfect one of putting a 30-ohm resistor across socket prongs 2 and 3—making it possible to use both tube and pilot light.

The battery-type tube has been neglected in these discussions. Possibly there has been a tendency to consider that lack of batteries rather than lack of tubes would be the factor limiting the usability of portable receivers. The large number of three-way sets being used on the power lines may have been overlooked, or the fact may have been that small sets are not always used as steadily as the straight A.C.-D.C.'s, thus delaying the moment when tube problems become serious.

Whatever the cause, little attention was paid to these tube types, and replacement information in detail was not forthcoming. The result has been that many sets have been laid up because of "irreplaceable tubes"

COLUMN 1	COLUMN 2	CHANGES REQUIRED										
		No Change	Fil. Volts	Fil. Current	Rewire Socket	Change Socket	Realign	Add Top Cap Connection	Remove Top Cap. Conn.	Reduce Bias	Increase Bias	Change Oper. Voltg.
Types on WPB List	Use to Replace	A	B	C	D	E	F	G	H	K	L	M
1A5GT/G	1A5G 1A5GT 1F4 1F5G 1LA4 1LB4	A										
1A7GT/G	1A7G 1A7GT 1B7G 1B7GT 1C7G 1D7G 1A6 1C6 1LA6 1LC6	A										
1C5GT/G	1C5G 1C5GT 1G5G 1G5GT 1G5GT/G	A										
1H5GT/G	1H5G 1H5GT 1B5/25S 1H6G 1LH4	A										
1LA4	1A5G 1A5GT 1A5GT/G 1F4 1F5G 1LB4 1LA4											
1LB4	1A5G 1A5GT 1A5GT/G 1F4 1F5G 1T5GT											
1LC6	1LA6 1A7G 1A7GT 1A7GT/G 1B7G 1B7GT 1C7G 1D7G 1A6 1C6											
1LD5	1F6 1F7G 1E4G 1G4G 1G4GT											

\*On WPB list.

Servicemen will find the chart above a great help in their desperate struggle to keep our wartime radio sets operating in the face of prevailing scarcities. "Approved" types, which will continue to be manufactured, are listed in the first column, and in the second are listed those tubes which may be replaced by them. A special feature is the listing in the second column of



# TUBES FOR RECEIVERS

## TUBE SHORTAGE CAUSED BY UNEVEN PRODUCTION

and in those instances where the Serviceman set out to make replacements, much time was lost looking up manuals and checking characteristics to discover what tube could successfully be substituted for the given defective one.

The lacking information is supplied in detail in this replacement tube chart, which was prepared by the Editors of *Sylvania News*. The standard WPB tubes are listed in column 1, and tubes which may be replaced by each of these types are listed opposite in Column 2. It will be noted that some of the standard WPB tubes are also listed in Column 2. The reason for this is that it is by no means certain that all the WPB tubes will be obtainable at all times. Where one of these can be replaced by another, it is so listed.

The lettered columns indicate just what changes must be made to the circuit before the standard tube can be used in it. In some cases, for instance, it is merely necessary to change the socket, in which case the change is indicated by the letter E following the tube to be replaced. Where it is necessary to reduce or increase bias or plate voltage, the exact information can be quickly looked up in the manual. The general arrangement is such that the Serviceman may see at a glance what tube may be used to replace any defective one he may have, and what changes are necessary to make the adjustment.

For example, a portable comes in with a burned-out 1A7-G. If it were possible that the serviceman exists who does not know that the tube is identical electrically with the 1A7-GT/G, a glance at the chart would tell him that the approved type may be inserted without change.

The situation is different if the burned-out tube is a 1A6. Now the chart shows that the filament voltage and current both have to be changed. The one necessitates a series resistor in the case of sets with a 2-volt supply, whereas the other may call for a shunt series hookup.

The slight difference in filament current which might well be tolerated in any other tube in the set, would possibly cause difficulties in an oscillator. Glancing further along the chart, he notes (E) that the socket must be changed, (F) that re-alignment is necessary, and (M) that the operating voltages of the two tubes are not the same. In most portables, the maximum rating of the 1A7-GT/G will not be exceeded, of course.

The chart can also be used as a means of substituting one non-preferred type for another. For example, the serviceman working on this job may have a 1D7G which, by the chart, varies from the 1A7-GT/G roughly as does the 1A6.

Other replacement possibilities are suggested by a study of the chart, which should be a very useful reference for the serviceman, and may be worth clipping and mounting on cardboard near his bench.

THE tube shortage is a matter of scarcities in certain types, rather than a general tube famine, according to officials of the Radio and Radar Division, WPB. Spotty production and runs on certain types are the chief reasons for the situation, which will be to some extent corrected within the next few weeks, with a more balanced production schedule in view for the rest of the season.

The shortages are especially acute, as all servicemen are aware, in certain types of tubes used in low-price modern A.C.-D.C. receivers. Because of the low margin of profit in these tubes, manufacturers engaged in war production have tended to slight them in favor of better-paying items. These scarcer types are now being concentrated upon at the suggestion of the Board.

There are of course shortages of tubes which are "naturals" for war use. The services are absorbing practically the full output of these, and probably will continue to do so for some time. Some of the most troublesome problems have, however, been presented by the lack of just such small A.C.-D.C. rectifiers, power amplifiers and combination tubes apparently referred to in the statement of the War Production Board.

Two difficulties have tended to aggravate the shortage. No one manufacturer makes a complete assortment of tubes, so dealers have incomplete stocks. The case may arise where two dealers duplicate each other through eighty per cent of their stock, while only one, or neither, carries certain needed types. Moves have been made toward an exchange of tube supplies between manufacturers, toward the end that dealers may carry better balanced lines.

The other trouble is that many tubes manufactured in the civilian tube replacement program are purchased by contractors working on military orders, or even by military purchasing agents, and thus never find their way into the receivers of the civilian consumer. The WPB recently asked makers to mark all civilian tubes "M.R." (Maintenance and Repair) to indicate that they had not been subjected to the rigid tests required by the armed services. This, it was thought, would cut down purchases of these tubes for military purposes.

This plan has not met with the whole-hearted approval of all the manufacturers. RCA recently notified its dealers that "to meet the desires of the Army and Navy" it would brand all tubes manufactured and sold by RCA with the RCA trade-mark. Tube makers have often purchased unbranded tubes from other manufacturers, said the statement, and sold such tubes under brand names different from that of the actual manufacturer, thus making it possible for manufacturers to offer a more complete line of tubes under their own or customers' brands. This practice is to be discontinued. "We may no longer be able to supply certain tube types with RCA brand names where such tubes are not actually in production on our own manufacturing facilities," says the statement.

Meanwhile, reports of sets being forced into inactivity through tube shortage are piling up. The National Association of Broadcasters has undertaken a wide survey, the results of which have not yet been made public. Estimates of as high as 100,000 sets silent in Detroit and approximately the same number in Philadelphia were made by the *Wall St. Journal*.

COLUMN 1 Types on WPB List	COLUMN 2 Use to Replace	CHANGES REQUIRED										
		No Change	Fl. Volts	Fl. Current	Rewire Socket	Change Socket	Realign	Add Top Cap Connection	Remove Top Cap. Conn.	Reduce Bias	Increase Bias	Change Oper. Voltg.
		A	B	C	D	E	F	G	H	K	L	M
1LH4	1G4GT/G					E	F			K		M
	1H4G		B	C		E	F			K		M
	*30		B	C		E	F			K		M
	1H5G					E	F		H			
	1H5GT					E	F		H			
1LN5	*1H5GT/G					E	F		H			
	1B5/25S		B	C		E						M
	1H6G		B	C		E						M
	1LC5						F					M
	1N5G					E	F		H			
	1N5GT					E	F		H			
	*1N5GT/G					E	F		H			
	1A4P		B	C		E	F		H			M
	1A4T		B	C		E	F		H			M
	1B4P		B	C		E	F		H			M
1N5GT/G	1D5G		B	C		E	F		H			M
	1D5GP		B	C		E	F		H			M
	1D5GT		B	C		E	F		H			M
	1E5G		B	C		E	F		H			M
	1E5GP		B	C		E	F		H			M
	1E5GT		B	C		E	F		H			M
	1N5G	A					F					
	1N5GT	A					F					
	1A4P		B	C		E	F					M
	1A4T		B	C		E	F					M
	1B4P		B	C		E	F					M
	1D5G		B	C		E	F					M
	1D5GP		B	C		E	F					M
	1D5GT		B	C		E	F					M
	1E5G		B	C		E	F					M
1E5GP		B	C		E	F					M	
1E5GT		B	C		E	F					M	
1P5GT/G	*1LN5					E	F	G				
	1LC5					E	F	G				M
1Q5GT/G	1P5G	A					F					
	1Q5G	A										
1T5GT	1Q5GT	A										
	305G				D							
	305GT				D							
	*305GT/G				D							
	1A5G		B	C								M
305GT/G	1F4		B	C		E				K		M
	*1LB4											
	305G	A										
30	305GT	A										
	1Q5G				D							
	1Q5GT				D							
	*1Q5GT/G				D							
	1G4G		B	C		E				K		
34	1G4GT		B	C		E				K		
	1G4GT/G		B	C		E				K		
	1H4G					E						
	1E4G		B	C		E					L	
	*1LE3		B	C		E					L	
32	A											

\*On WPB list.

"approved" types as well as others, so that if one of these may happen to be unobtainable, information as to replacements is available. This list supplements the earlier one published July last. It is expected that further up-to-date schedules will be printed as required by the changing tube situation.



1—"Launching" the aerial prior to transmission.  
2—The power supply of the Gibson Girl at work.  
3—Sending out an automatic call for assistance.



## PLANE-WRECKED AVIATORS SAVED BY "GIBSON GIRL"

THE Gibson Girl, favorite of the late nineteenth century, has a modern mechanical counterpart, which, from present indications, is destined to become the sweet-heart of the Air Forces.

Affectionately referred to as the Gibson Girl during its secret development by engineers of Bendix Aviation, Ltd., of North Hollywood, Calif., the device is a hand-powered, foolproof emergency radio transmitter, designed to speed the rescue of airmen forced down at sea. The majority of engineering work was done at Aircraft Radio Laboratory, Wright Field.

It weighs 33 pounds, including all accessories, has a modified hour glass figure reminiscent of the Charles Dana Gibson heroines, and is unsinkable and waterproof. By simply turning a small crank, the transmitter generates an automatic S-O-S with an effective range of 100,000 square miles.

Thousands of sets of the Gibson Girl have been turned out for the army air

forces and already reports are being received of ocean rescues, made possible through "emergency radio transmitters."

The device is pretuned to the International distress frequency of 500 kilocycles. The only prerequisite to sending is the raising of an aerial by kite or balloon. The kite can be flown with a high wind velocity, while the balloon is raised in more moderate weather. Hydrogen for the balloon can be developed by immersing a simple generator in the sea.

The balloon or kite is flown with light wire, attached to the Gibson Girl. The aerial attains excellent results when the balloon or kite reaches an altitude of about 300 feet. In tests, these balloons, which are five feet in diameter, have shown themselves capable of remaining aloft under adverse weather conditions for as long as a week.

By turning the crank on the transmitter, a system of gears and discs, attached to the

crankshaft, spells out the S-O-S. The Gibson Girl also provides a radio signal which can guide searching planes to the life raft.

In addition to these automatic features, the set can be operated by hand, enabling an experienced radio operator to send any desired message. It is also equipped with a signal light, power for which is likewise supplied by the hand crank. The light can be operated manually for signaling rescue parties or for illumination.

Suppose a plane crew is forced down at sea. As a crash impends, Gibson Girl equipment, especially packed for such an emergency, is parachuted. It is also possible for a searching land based plane, unable to help otherwise, to drop equipment. Through the emergency transmitter, the distressed crew can keep searchers posted on its position via the automatic radio signal.

Until recently, the Gibson Girl and ac-

(Continued on page 630)

## "STARS AND STRIPES OVER EUROPE"

(COVER FEATURE)

RELATEDLY the United States Government is beginning to blanket the world, and particularly Europe, with the Voice of America. Before Pearl Harbor, the Government did not have any radio stations to disseminate American propaganda all over the world, as for instance Germany had done for years.

After Pearl Harbor, the United States took over a number of American stations. By the end of 1941, the U.S. Government had ten not very powerful short-wave stations on the Atlantic Coast and only one station on the Pacific. At the same time Germany had almost 70 short-wave transmitters, to which must be added those in the occupied territories. It is understood that Germany is constructing over 20 additional short-wave transmitters of over 200 kilowatt power.

At the present time there are some 24

transmitters being used by the Office of War Information in the United States, but at least 25 additional and more powerful short-wave transmitters are needed. Most of them will be ready by the end of this year.

When the United States sends a blanket of American news to Europe and the rest of the world, it does so by addressing the various nations in their own language. The present daily schedule in transmitter hours is, roughly, as follows: American broadcasts to their respective countries:

- In French, 63 hours, 00 minutes;
- In German, 17 hours, 45 minutes;
- In Italian, 19 hours, 30 minutes;
- In Spanish, 9 hours, 30 minutes;
- In Japanese, 6 hours, 45 minutes;
- In Chinese, 4 hours, 20 minutes;
- In Czechoslovakian, 1 hour, 35 minutes;
- In Danish, 1 hour, 15 minutes;

- In Arabic, 1 hour, 15 minutes;
- In Swedish, 1 hour, 15 minutes;
- In Finnish, 45 minutes;
- In Bulgarian, 35 minutes;
- In Greek, 15 minutes.

At the present time these American broadcasts addressed to the Foreign Nationals are all on short-wave, except for American broadcasts which will emanate from England and from North African transmitters, which are on standard wave lengths. (Most of these transmitters are not in operation as yet.)

The short-wave broadcasts, going to Europe particularly, cannot be very effective except perhaps in France and Germany, and even here only a comparatively small number of French and Germans can possibly listen to our transmissions. Any one

(Continued on page 630)

# KEEP 'EM PLAYING

By M. J. EDWARDS

**T**HE front line soldier's job in this war is to kill or maim as many as possible of the enemy in the shortest space of time possible, under any and all conditions and with any weapon at hand. If his gun is shot out of his hand, it is necessary for him to use knife, bayonet, grenade, or even bare hands. In a foxhole one has no time to tell the enemy, "You will have to wait a few weeks or months, until I can get an exact duplicate gun part before I can fight you." Before he could finish his statement he would be dead. Yet a similar mental attitude seems to have been adopted by far too many of our servicemen. The serviceman's job in this war is to keep those radios and electronic devices on the home front in good working order. If he advertises Radio Service, he should give SERVICE, not alibis. The excuse that he cannot get the particular tube or part needed; therefore the radio cannot be fixed is no use to his customer. That way of thinking is the serviceman's enemy on the home front.

Radios and electronic devices CAN be put back in good working order, and with the parts available. It will at times require the expenditure of a little extra time, and a bit of ingenuity; but the results will be worth the time and trouble required when the serviceman sees the happy smile on the face of another radio owner who can once again keep up with the news and learn without waiting for tomorrow's paper that it was not Johnny flying the POLLY JEAN, who crashed, but must have been some other bomber and pilot.

## THE FAMILY'S RADIO IS IMPORTANT!

It is well to keep in mind that when a person comes into a radio shop nowadays with a little radio under his arm and a hopeful look in his eye, it is not just some old fogey dragging in a Super Duper crackerbox with a blown out 35Z5 and 50L6 that you cannot get anyway, but is in all probability the representative of a family that has one or more boys at the front. He is bringing in for quick treatment the little friend who keeps the entire family abreast of events as they happen, and also brings them music and laughter which keeps them from worrying too much about Johnny.

Having once realized that he is not merely selling parts and tubes, but that he is actually and literally providing Home Front morale by keeping news and entertainment available to each family, and that he is also helping in the sale of war bonds, aiding in Civilian defense, and aiding many other war activities merely by fixing the little crackerbox the old fogey brought in under his arm, so he and his family could hear all that is said over the air, he is ready for the next step.

## NO "IMPOSSIBLE" SERVICE JOBS

He should now eliminate the word "can't" from his vocabulary. For every shortage there is a good substitute. A few examples will be given, but it must first be remembered that there is no substitute for intelligence, ingenuity, or hard work. No hard and fast rule for specific substitutions can

be given, for the simple reason that all shortages are not the same in all areas, and the available substitutes do not remain the same in a given area for two weeks in succession. Instead, a method will be given for adapting one's available supply to the job confronting him. During the pre-war days the plentiful supply of duplicate parts and tubes simplified the service problem to where most repairs were a routine proposition. This caused many shops to get in a rut; thus losing sight of the fact that the very fundamental laws governing radio circuits are the most valuable and inexpensive tools available to the serviceman.

The first step in overcoming the present shortage is to review those laws and learn to apply them to practical problems which arise daily. Learn again the PURPOSE of each part or tube in a circuit, the ultimate effect of its presence in a circuit. Disregard the trade name or number of the circuit components, and look at them as the other components in the radio see them; that is, by their function. Then review all of the alternate methods, both old and new, by which the same ultimate effect may be achieved.

## USE THE SERVICE MANUALS

The easiest place to find all these alternates is in the stack of tube and circuit manuals on the shelves of every radio shop in the country. Pick out any particular type and size of radio, then go through the manuals and see how each different manufacturer goes about the job of accomplishing the same ultimate result with a given number of tubes of generally similar types, yet with entirely different type numbers and an altogether different set of circuit components. A five tube midget by one manufacturer using a 12SA7, 12SK7, 12SQ7, 35Z5, and 50L6, will sound and perform exactly like another make using a 7A8, 7B7, 7C6,

35Z3 and 35A5, or another using 6SA7, 6SK7, 6SQ7, 25L6, and 25Z6. Therefore, what the various factories do in original design, the serviceman can do in redesign. One need not be an engineer to make these changes. All he needs is ingenuity, common sense, the ability to read a tube manual and a circuit manual; to understand what he reads and apply this understanding to the job on the bench.

## THERE ARE PLENTY OF SUBSTITUTES

For a few specific examples, let us take the 12 and 35 volt, .150 ma series that is so scarce at present. The 12SA7 seems to present a bugaboo to many servicemen due to the fact that the possible substitutes drawing the same filament current contain an oscillator anode grid which is lacking in the 12SA7. Simply use a 12A8 or 7A8, to cite two examples, and tie the anode grid to the screen grid; then you have an exact electrical duplicate. Of course in the case of the 7A8 it will be necessary to make a socket change and add a series filament resistor which figures about 40 ohms, but can be in practice any value from 20 to 60 ohms. One can also cut out the entire filament circuit of the 12SA7, adding in its place a resistor of about 80 ohms, then use any of the battery type pentagrid converters with fine results. Just measure the D.C. voltage at the rectifier cathode, subtract the filament voltage of the tube to be used, divide the result by the filament current and you have the value of the resistor required to supply filament current direct from the rectifier cathode. It is best to add a 150 volt filter condenser, about 20 mfd., to the filament side of the dropping resistor.

In the same manner, substitutes for the other tubes may be found. The 12SK7 may be replaced by the 12K7, 7B7, 1N5, 1LN5,

(Continued on page 628)



Mr. Edwards tells us that the above photograph was taken while making some of the substitutions suggested in the article above. Readers will recognize close-up views of the bench seen in the March Mail-Bag.

# New DEVELOPMENTS IN

**W**HEN a radio program wins a prize it is the actors, the script writer and the director who receive the credit.

Yet in many instances the sound men have contributed immeasurably to the program's success. Almost any director will tell you how much he owes to the diligence and ingenuity of the sound men. These men must be able to distinguish between the multitudes of sounds and to reproduce any sound which may strike the imagination of a script writer or director.

A trip through the sound department at Columbia Broadcasting System gives evidence of the great strides made in this branch of radio in the past few years. Not so many years ago, sound men had to construct all sorts of mechanical contrivances to secure the required effects. Today most sounds are recorded, catalogued and filed in the sound library to be pulled out as needed.

Hundreds of records, ranging (to quote from a catalogue devoted entirely to sound effects) from airplanes (21 different varieties on as many records) ambulances and apes; to wedding marches, winds and wolves. These records are available not only to broadcast stations over the country, but to the individual who may find sound-effects useful, and it is said that many of the model-railroad fans operate their microscopic lines to the accompaniment of recorded locomotive whistles and wheel sounds reproduced by powerful amplifiers at higher-than-life levels.

## THE OLDER DEVICES REMAIN

But the old sound-men of the pre-record days did their jobs and did them well. Many of the mechanical devices to imitate sounds that they invented have been found to give a better illusion over the air than the recording itself. Thus many of the classic sound-effect machines are still being used.

Among the mechanical sound devices now in use are: a group of wooden pegs suspended on rope and enclosed in a wooden frame which is moved along a board

to produce the sound of marching men; a metal box containing a motor driven fan and four rattan sticks, called a "wind" machine and a hand turned wheel on a wooden roller, used to produce the familiar sound of wagon wheels. A gadget consisting of two wooden blocks, one fitting into a groove in the other and held together with a screw, gives the sound of a door squeaking; a "splash" machine—a small metal tank, lined with canvas, with a metal hand operated paddle—is used to stimulate the sound of a man "overboard"; ice box doors in miniature produce the sound peculiar to aeroplane doors when swung open or shut; and a paper carton is slid over a cloth filled with pebbles when a script calls for the beaching of a boat.

## NEW WARS—NEW TECHNIQUES

With the outbreak of World War No. 2 and the increase in the number of war programs, sound technicians had to create a whole new group of "war" sounds. No longer did sound directions read simply "sound of aeroplane overhead." Now they specified "a bomber," "a fighter," or "a pursuit ship," and woe betide the sound man who tried to pass off one for the other.

The sound man's job is far more complicated than just selecting a record from his shelves and playing it on a machine. Sounds have to be blended as, for instance, in battle scenes. Frequently it takes four or five records all playing at once to secure a desired effect. Background noises must be kept in the background and not be permitted to intrude or drown out the voices of the actors. Frequently one noise has to be superimposed on another as in a battle scene where the rumble of guns, tanks and machine gun fire continue incessantly in the background while nearer at hand a single rifle shot will ring out, or a hand grenade burst. To secure this effect two microphones are used—one to pick up the general battle noises and the other the foreground sounds.

In the recent "Flying Fort" episodes of

the "Man Behind the Gun" series, all action takes place inside the plane and the sound man was faced with the problem of producing that steady hum of the four motors as it would sound to people in the plane and holding that sound throughout the entire program, yet making certain it did not drown out the dialogue or distract in any way from the action. The sound man used what he called a "panorama" arrangement—two amplifiers placed on either side of the microphone. Three recordings of airplane motors were played at the same time to get the proper effect. The result was so successful that CBS received many letters from enthusiastic listeners, and the sound man carried the rumble of the motor in his ears for days.

## ICE-CREAM FREEZER "DEPTH BOMB"

Another "Man Behind the Gun" program dramatized the Coast Guard Cutter Campbell's heroic fight with a pack of Nazi submarines and her final ramming of one of these undersea raiders. The sound department experimented with various explosion records but found none satisfactory. They all lacked the metallic sound peculiar to a depth charge as it finds its mark. This was finally secured by playing a recording of cannon fire at low speed into an amplifier over which was placed a metal ice cream container. The sound came out of the amplifier, bounced off the tin and was picked up by the microphone. The sound, as it went out over the air, had a true metallic quality. When the Campbell rammed the Nazi submarine, three records were played at one time—an excavator record, a train crash record and one of cannon shots. The combination was quite competent to produce all the scraping, grinding, squealing noises that would be expected when two such sea monsters came together.

One reason for the high quality of the "Man Behind the Gun" series, recent winner of the coveted Peabody Award, is the careful research that goes into the preparation of the scripts and the direction of the programs. An example of this oc-



1.—The "squeak box," WOR's latest. It can produce any squeak from the sound of a pair of Caspar Milquetoast shoes to the swinging of a heavy castle gate. The turning shaft, leather belt and adjusting screw are easily seen in the picture. 2.—Thunder from the studio. The sound man strikes a tympani mallet against a sheet of metal wired to an amplifier. 3.—Three of the new "squeak boxes." The center one is the latest edition, used on such shows as "Murder Clinic," "Highway Patrol," "Nick Carter," "Superman" and others. 4.—A staff of four sound-men were required to handle the effects during the dramatization of a bombing mission to Hamm, Germany, aboard the Flying Fortress, "Stormy Weather."

# RADIO *Sound* EFFECTS

curred in dramatizing an incident in which the commanding officer of a submarine gives the order to fire a torpedo. The sound technician, during the first rehearsal, used a compressed air tube for the noise of the torpedo as it was released. He had used this same medium on other occasions to produce this effect and it had always been considered very fine. But Bill Robson, the director, wasn't satisfied. Robson had actually stood in the control room of a submarine at just such a moment, and this was not the sound he had heard. What he had been aware of on that occasion was a hissing noise, such as steam makes when it is released, and nothing but that sound would satisfy him. The fact is that when a torpedo is released it sounds quite different to the men in the firing room and to those in the control room. Only someone who had had the exact experience would have been aware of this difference.

## THE PIT AND THE PENDULUM

The sound-man not only retains many of his old tricks—he is sometimes forced to invent new mechanical illusions, even in these days of recordings from A almost to Z. Such was the case when Edgar Allan Poe's horror masterpiece, "The Pit and the Pendulum," was broadcast.

The story is that of a man sentenced to execution by a peculiar and horrible method. Lying on his back, secured so firmly that only his left hand can move, the victim watches the swinging of a huge knife suspended above him. The center and lowest point of the arc is directly above his breast, and the pendulum *descends* inexorably with each swing. In the words of the fictitious hero, "the pendulum's nether extremity was formed of a crescent of glittering steel, about a foot in length from horn to horn; the horns upward, and the under edge evidently as keen as that of a razor. Like a razor, also, it seemed massive and heavy, tapering from the edge into a solid and broad structure above. It was appended to a weighty rod of brass and hissed as it swung through the air."

All that the sound men had to do was to re-create that swinging, hissing pendulum. There was nothing in the library of

sound records to even suggest the effect, nor did any of the sound men's early experiments bear fruit. Finally one technician discovered the method. Climbing onto a high cabinet, he swung a live microphone in a wide arc, passing by the slightly opened hissing nozzle of a tank of compressed air at the lowest point of its swing. Thus was one pendulum pressed into service to imitate another.

One of the most elaborate and effective of the mechanical sound effects is in fact of recent invention. This is the famous "creak-box" of Station WOR. A versatile device, it can reproduce a variety of creaks, squeaks and cognate sounds, ranging from the light sounds produced by a pair of new shoes to the low-toned grating noises required in the "grippy-door" type of program.

The box part of this apparatus acts merely as a resonator and mounting for the actual squeak-producing mechanism. This consists of a round wooden shaft mounted between two bearings with a straight handle at one end, by which it may be turned. A piece of leather belting passes around the shaft. The ends of the shaft run out to a bolt at the end of the box, so arranged that by turning a thumbscrew, the leather strip may be drawn up against the shaft with greater or less tension. Squeaks are changed in pitch and timbre by varying both the friction and the speed of turning the shaft.

## THE SOUND-CANNER'S PROBLEMS

The recording man, too, has his moments. One such was assigned to bring in the voice of a howling dog. No technique he could master would produce howls of the timbre desired, and he was desperate. Wakefully pondering his problem at 3 a. m., he was aroused by just such howls as he had been searching for. The howls were produced by a dog a few doors down the street, and the sound-man lost no time. Attired in his nightshirt only, he maneuvered his sound truck into a vacant lot next door to the house of the howling dog, and started to record. Almost immediately police appeared on the scene, to arrest a

"crazy man dashing around in his night-clothes." His explanations were received as just that much more evidence of his insanity, but a play-back of the recorded howling convinced the officers that he was probably only partially insane.

Another use of sound effects is to create the illusion of reality in a theater. The Stevens Institute of Technology has a theater fitted up almost as an experimental laboratory in such effects. Walt Disney introduced the technique to a wide audience with speakers in the various parts of the hall in "Fantasia."

## BRINGING PLAYS TO THE AUDIENCE

This type of theater can be carried to much greater lengths. In one play, a burglar was pursued over a roof-top by police. Sounds of the chase through speakers first here, then there, in the darkened theater, carried the audience in illusion to the very roof of the pursuit, where they lived the emotions of the trapped burglar. Planes have circled and come in to land—apparently in the middle of the audience—through the agency of speakers spiralled along the ceiling. Movie audiences are more sophisticated than they were in the early days of the art, as there is no record of any mass attempt to get out from under, in sharp contrast to the first movies, when a runaway horse dashing down the screen toward the audience could be depended on to empty several seats in the first three rows. There is an account, however, of rain being reproduced so realistically from the ceiling speakers that a number of the audience rushed out to shut the windows of their cars.

In these, as in the simpler effects of the broadcast play, the sound-man is the anonymous artist whose skill makes or mars the program. Leaving the credit to the author and playwright, and applause to the players, he envies neither, and is satisfied with a workmanlike job well done.

All photographs in this article reproduced by courtesy of Columbia Broadcasting System and Radio WOR.

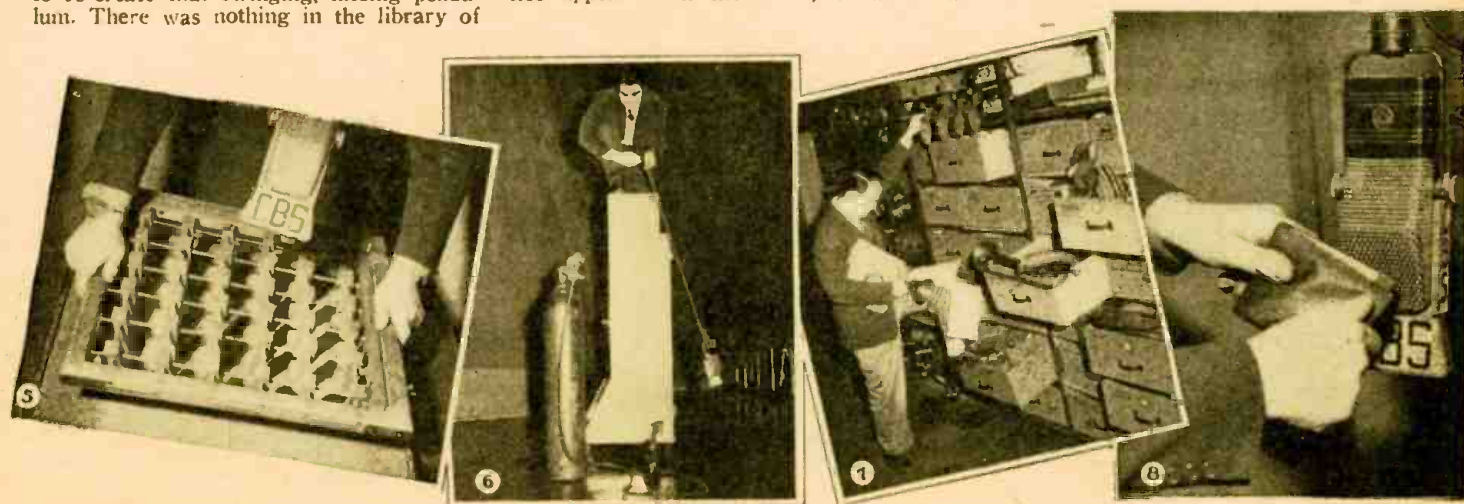

5.—Whole regiments of marching men are simulated by this classic device. It consists of rows of wooden pegs suspended on rope and enclosed in a wooden frame. The skilled soundman moves it across a board to get the effect desired. 6.—Set up for the "Pit and Pendulum" program. This was one of the most impressive of recent sound effects. 7.—Selecting the necessary "properties" from a well-stocked "sound library." These drawers of various devices are now often superseded by recordings of desired effects. Several such records may be seen under the sound technician's arm. 8.—A simpler type of squeak apparatus, used to imitate squeaky shoes. The sound is produced by twisting a leather wallet in front of the microphone.

# MORE HIGHS — MORE LOWS

## PART I

By LEO G. SANDS

**W**ITH the non-availability of new radio receivers and new public address amplifiers, many radio technicians will be interested in simple and inexpensive methods of improving the frequency response of their own and their customers' equipment. The author has done extensive experimenting with various bass and treble boosters and wishes to pass the

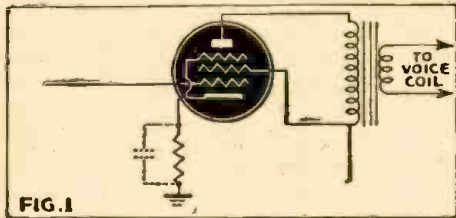

FIG. 1

information thus derived to his fellow radio technicians.

The tone control, as it is called, in the majority of radio receivers and amplifiers usually consists of a variable resistor and a condenser. This system gives an apparent bass boost by cutting the highs, and to the author's ear, is highly unsatisfactory. Other tone controls give the same result by a switching arrangement that throws a condenser across the audio circuit to cut the highs. There are many ways by which the bass may be boosted without cutting the

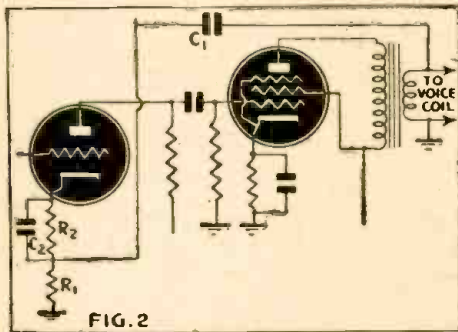

FIG. 2

highs. Likewise, the highs can be boosted without affecting the bass response.

Let us first consider bass boosters. Fig. 1 illustrates one of the simplest. In a single ended audio system, the cathode by-pass condenser can be removed to permit degeneration. This in turn usually results in increased bass response. There is a slight loss of gain. Fig. 2 illustrates another system using degeneration or inverse feedback. This is accomplished by feeding back part of the output voltage to the cathode of the first audio stage. The feedback signal is applied at the cathode. The amount of feed-

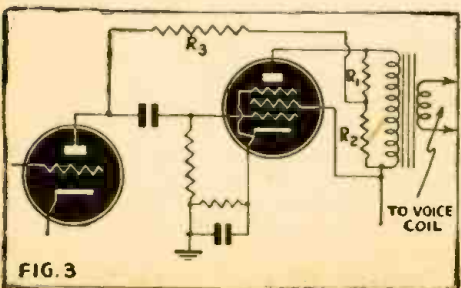

FIG. 3

back is varied by choosing the desired value of  $R_1$ .  $R_2$  is the bias resistor for the first stage.  $C_2$  is the cathode by-pass condenser and should be as large as possible, so that the low frequencies will be adequately by-passed.  $C_1$  regulates the amount of feedback as well as the frequency response. If the condenser is small, it will offer a high reactance to the lower frequencies and offer more degeneration at the higher frequencies, thus allowing greater bass response. Fig. 3 illustrates another inverse feedback system. In this case, the plate load resistor of the first audio stage is connected to a voltage divider across the output transformer. The ratio of  $R_1$  to  $R_2$  determines the percentage of inverse feedback.  $R_3$  is the plate load resistor. This modification can be readily made on most of the inexpensive receivers using a single ended output stage.

### AN EFFICIENT BASS-REINFORCER

More elaborate bass boost circuits use various resistance-capacitance-inductance networks. In Fig. 4, we have a system that uses inverse feedback and a choke coil. In this circuit, a part of the output voltage is fed back to the grid. The grid load resistor is disconnected from the ground or bias circuit, and a small choke coil of approximately 10 henries is placed in series with the grid return. The output voltage is fed through  $R_2$  and  $C_1$  to the junction of the choke and grid resistor.  $R_2$  prevents the condenser  $C_1$  from feeding back too much of the high frequency signal. The value of  $R_2$  and  $C_1$  is best determined by experiment, as there are so many factors that enter the problem from one radio receiver to another. In practice, the author has found that  $L_1$  can be the primary of an output transformer similar to that used in the midget variety of radio set. A 2500 ohm speaker field removed from the speaker frame, and thus becoming an air core inductance has worked out very satisfactorily. The results from this circuit are astounding in some cases. In this circuit, the inverse feedback cuts the gain at all frequencies. The choke then offers a low impedance path for the low frequencies and we obtain a decided bass boost. This circuit may be made variable by placing a 100,000 ohm potentiometer between  $R_1$  and ground and connecting the choke from the arm of the potentiometer to ground. In this way, the effect of the choke is varied. This circuit may be applied to the output stage, or for an even more pronounced effect, in one of the input stages.

Fig. 5 is a modification of the above described circuit. Two potentiometers are used. On the arm of one is the choke, and on the other a condenser (.002 approximately). This provides both bass and treble boost, and both are variable.

### RESONANT BASS BOOSTERS

Bass boosters that do not cut the gain or the high frequencies but actually boost the bass by offering more gain at the low frequencies are shown in Figure No. 6 and in the second half of this article. In figure No. 6, we have a modification that is very easily made in almost any radio receiver.

This circuit can be used in any of the audio stages. The grid resistor is removed and a choke ( $L_1$ ) is substituted.

The choke may be a high impedance type of any value from 100 henries up. The writer has used the secondary of an old audio transformer with success. Condenser  $C_1$  is selected so that  $L_1$  and  $C_1$  form a series resonant circuit that resonates at a

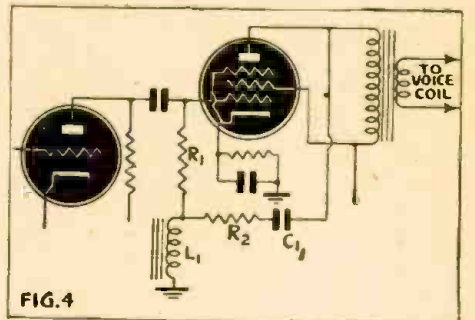

FIG. 4

low frequency. The writer uses 80 cycles with success. If a 100 henry choke is used,  $C_1$  should be about .05 microfarads. If a 250 henry choke is used  $C_1$  should be .015 microfarads. If you have no way to measure the inductance of the choke or transformer, try various size condensers until a decided bass boost is noticed. This booster may be

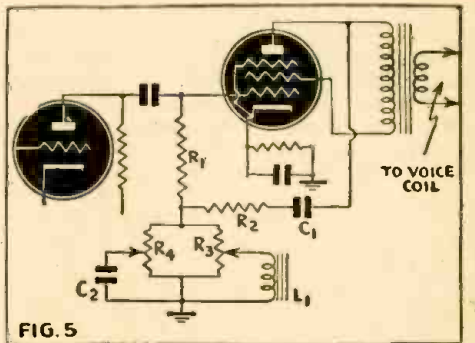

FIG. 5

made variable by placing a 250,000 ohm potentiometer from the grid to ground and connecting the choke from the arm of the potentiometer to ground. If the "Q" of the choke is extremely poor, there will be no great bass boost. If the "Q" is too great, it will have the effect of shorting out the plate load at resonance and will again have very little bass boost. A choke with medium "Q" will give very good bass response from about 20 cycles to 200 cycles with no cutting of the highs. Resonant circuits may "ring" at their resonant frequency and produce the hang-over effect on bass notes

(Continued on page 628)

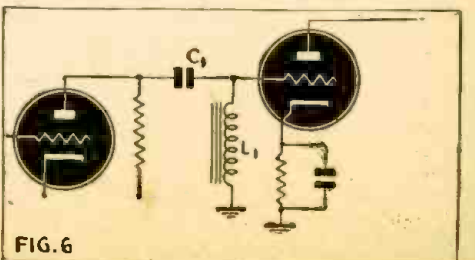
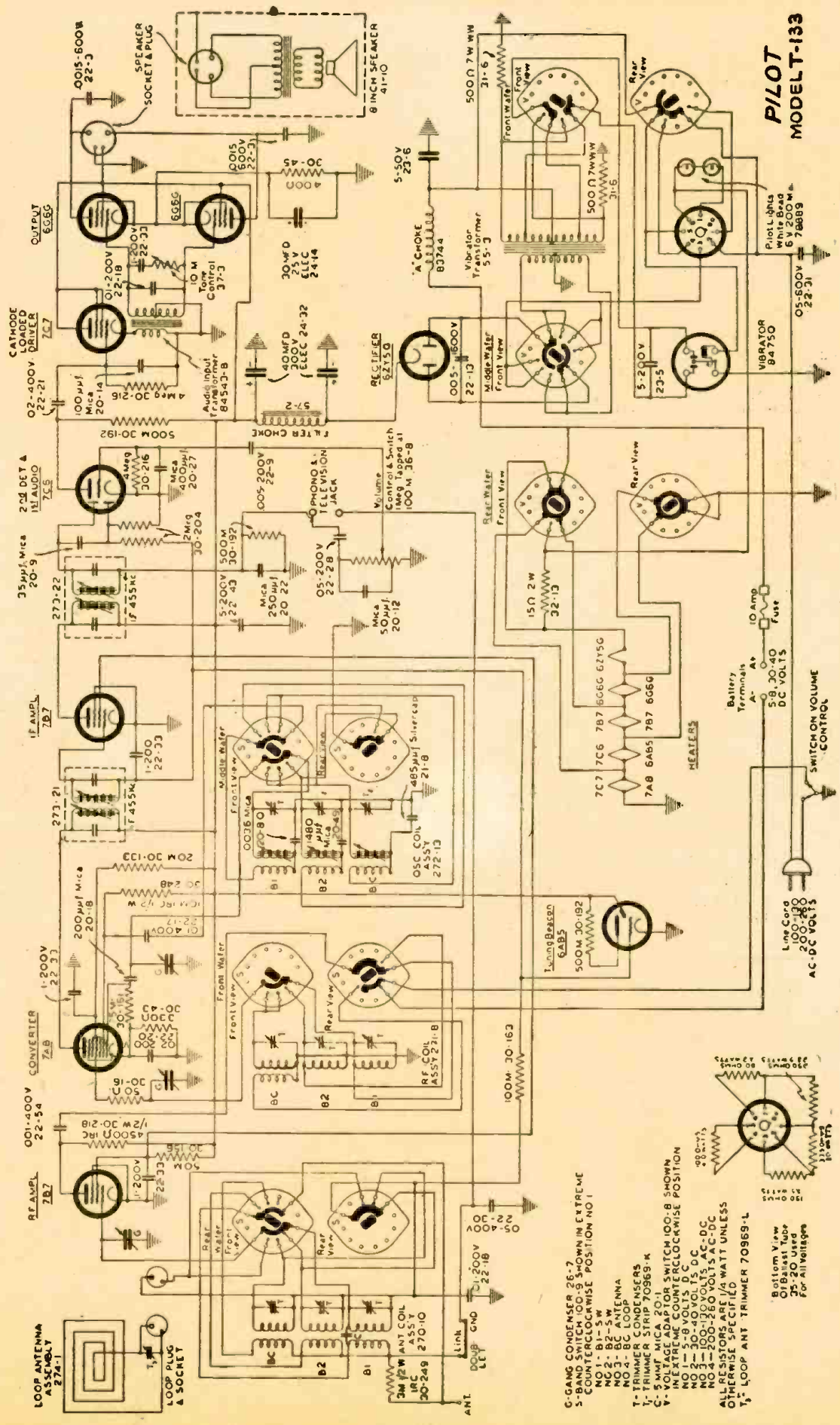

FIG. 6

# Radio Service Data Sheet

325



**PILOT  
MODEL T-133**

- C - GANG CONDENSER 26-7
- S - SWITCH 26-7 DOWN IN EXTREME COUNTERCLOCKWISE POSITION NO. 1
- NO. 1 - B1 - 5W ANTENNA
- NO. 2 - B2 - 5W ANTENNA
- NO. 3 - B3 - 5W ANTENNA
- T - TRIMMER CONDENSERS
- T1 - TRIMMER CONDENSER
- T2 - TRIMMER CONDENSER
- T3 - TRIMMER CONDENSER
- V - VOLTAGE ADAPTOR SWITCH 100-B SHOWN IN EXTREME COUNTERCLOCKWISE POSITION
- NO. 1 - 100-30 VOLTS, AC-DC
- NO. 2 - 100-30 VOLTS, AC-DC
- NO. 3 - 200-280 VOLTS, AC-DC
- ALL RESISTORS SPECIFIED IN WATT UNLESS OTHERWISE SPECIFIED
- T3 - LOOP ANT TRIMMER 70969-L

Bottom View  
Of chassis  
for all voltages

# SERVICING NOTES

## Trouble in . . . .

### . . . . ZENITH 120158

Great difficulty was experienced in lining-up a Zenith model 120158. In the first place, the complaint was reading off-scale and low volume, and much time was wasted. I finally decided to try pot luck and replace the 50-mmf. condenser in the oscillator circuit (C4 on factory diagram), and presto, the set lined-up and performed as good as ever.

### . . . . WESTINGHOUSE WR-271

The Westinghouse WR-271 also gave plenty of trouble, which was a very quick cut-off, in fact so quick was this intermittent reception it was impossible to get the test prods into the circuit before the set would return to normal. Anyway (as usual!) everything but the right unit was suspected. By keeping the test prod on the plate, and watching when the break appeared, a quick deflection of the meter was noted. This happened 7 times in 5 minutes. The answer is, cut out and replace the 1,000-ohm resistor supplying plate voltage to the 6K8 oscillator-and-modulator tube, and your trouble will be ended.

F. NOSWORTHY,  
St. Johns, Newfoundland.

### . . . . DELCO CHEVROLET, MODEL 985424

This is a two-unit set with audio section, power supply and speaker in a round housing connected to rest of set with a 5-wire cable. The auto-transformer-type input to the 6V6 grids was located in an inverted can sealed with pitch. Due to the heat within the housing, this pitch would run out and into the 6V6 sockets, causing poor connections.

I replaced this transformer with a regular two-winding input transformer as shown in the diagrams, with equal if not better results than when the original equipment was in use.

ARTHUR FOEHR,  
Pawtucket, R. I.

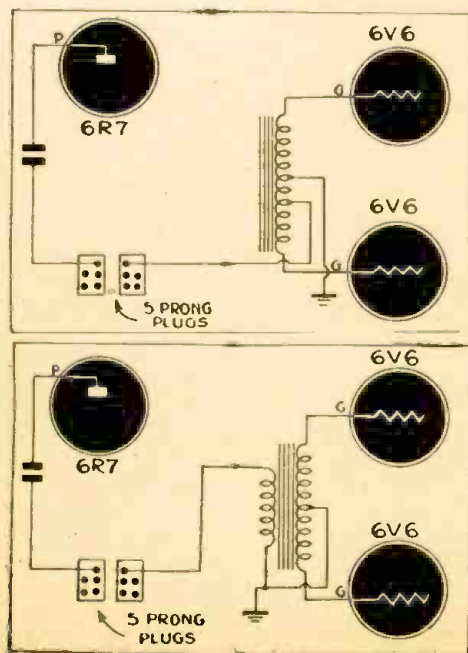

### . . . . RCA Q-24

Dead on short-wave bands. Under certain conditions the local oscillator in Model Q-24 receivers will oscillate at a parasitic frequency. This causes the set to be "dead" on one or more of the short wave bands. If this condition exists it can be corrected by connecting a 10 ohm, 1/4 watt resistor in series with the oscillator grid, mounted directly at the tube socket.

—RCA Service Notes

**ATTENTION SERVICEMEN!**

Do you have any Servicing Notes available which you would like to bring to the attention of the readers of *Radio-Craft*? If so, send them along and if they are published a one year's subscription to *Radio-Craft* will be awarded you.

### . . . . HIGH PLATE VOLTAGES

In Silvertone and other similar receivers I find that the plate voltage exceeds the manufacturer's tube ratings, especially on output tubes. I find that lowering the plate voltage 10 to 25 volts make for better performance, thus saving critical material. The little difference in volume can usually be made up by a tune-up. This will eliminate further troubles when high line voltage occurs.

JAMES DI CHIERA,  
Westernport, Md.

### . . . . STROBOSCOPE ANALYSIS

In adjusting vibrator points in service work—I use a 10 watt "Neon" lamp with the light shifting towards the vibrator points. This "Neon" lamp has the characteristic of making the points appear to stand still—thus permitting perfect observation of the point contacts in operating condition. Any arcing or pitted points will be easily detected and one can more easily see whether or not the vibrator is worth while repairing. After honing or filing the contacts, I wash the points thoroughly with "Carbon-Tet" which will remove all dust and filings. The approximately correct spacing of contact points can be much easier done due to their appearing to stand still.

NORMAL E. NELSON,  
Mayville, N. D.

### . . . . RCA 14BT-1, 14BT-2, 14BK

When excessive regeneration occurs in models 14BT-1, 14BT-2, and 14BK, the following procedure should be followed:

1. Make certain the grounding finger for 1N5GT tube shield is fastened to tube pin No. 1, which is grounded to receiver chassis.
2. Make certain that the metal rim of 1N5GT socket is soldered to the chassis.
3. Realign I. F. transformers, using stage-by-stage procedure as specified in service notes, and do not "touch-up" individual trimmers.
4. Unusually high-gain 1N5GT or 1A7GT tubes should be replaced with tubes having normal gain.

—RCA Service Notes

### . . . . FIRESTONE R1781 AUTO RADIO

No reception—no voltages. Shorted buffer condenser in vibrator circuit, (across secondary, between plates of 6X5). Replace with a .01 mfd., 2,000-volt condenser.

L. H. BREYMEYER,  
Manhattan, Kan.

### . . . . CROSLEY 52A

Intermittent noise and distortion. Check for shorts between dial face and the dial cord pulley. The variable condensers on this set are not at ground potential. Cementing a piece of insulating cloth to back of dial face will effect a repair.

A. DONOVAN,  
Langley Field, Va.

### . . . . G-E MODEL A-125

Fading or intermittent. Replace all the bypass condensers in the a.v.c. circuit with 600-volt units.

ROBERT BROOKING,  
North Platte, Neb.

### . . . . G-E, LATE MODELS

Models using phase inversion may have a loud hum.

Replace the phase inverter tube, whether it checks good or not.

ROBERT BROOKING,  
North Platte, Neb.

### . . . . SILVERTONE CHASSIS 101-487

Burned out 6B6-G. (Detector-a.v.c.-1st. A.F.)

I have replaced several of these with 6Q7-G's and had no further trouble with them.

This hint may be more useful now that non-standard tube types are hard to get.

H. C. O'DELL,  
Matoaka, W. Va.

### . . . . DEFOREST CROSLEY 851

A form of distortion very difficult to localize often occurs in these receivers. It is caused by an open-circuited .00025 mfd. mica condenser connected from the cathode end of the 100,000-ohm resistor, R<sub>5</sub>, in the 27 (diode-connected) 2nd detector circuit. This condenser is C<sub>12</sub> in the accompanying diagram.

Replacing this condenser often clears up very elusive and sometimes intermittent distortion.

GEORGE ROGAL,  
Paris, Ontario.

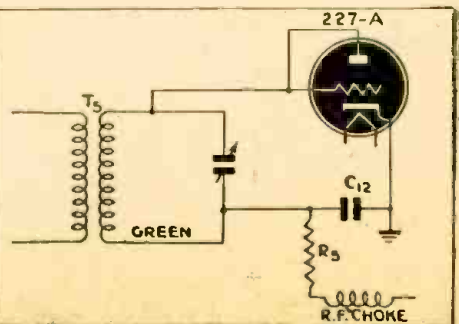



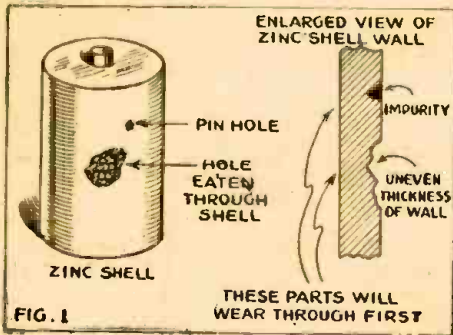

The question of "recharging" dry cells has bobbed up from time to time, with strong opinions expressed pro and con. Here is what an old-time battery man has to say on the subject.

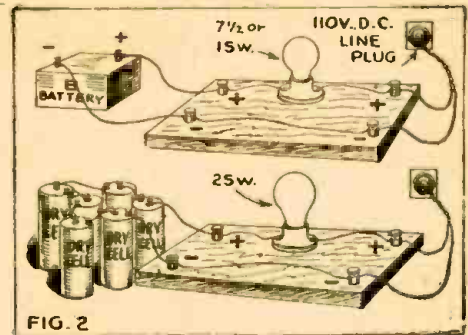

## Can Dry Cells Be Renewed?

**R**ADIO-CRAFT through the years has received many articles from various authors on renewing dry batteries. Frequently we also hear from readers who believe that dry batteries can be recharged and who wish details on the subject.

It is impossible in a few words to do the subject justice. For this reason, we print some observations made many years ago by Hugo Gernsback, editor, who formerly was in the dry battery business and a manufacturer of dry cells. Many authors will probably not agree with his observations, mainly because they are not sufficiently familiar with the subject. It is to be hoped that this article will be the means to set right all those who are interested in recharging dry cells.

Dry batteries or dry cells, in the opinion of Mr. Gernsback, cannot be successfully recharged, and the trouble of recharging them is not worth the poor results you get from the effort. Speaking generally, it might be said that recharging dry cells gives exactly the same results as inflating a "slow" leaky tire. In an emergency, when you must get somewhere quickly, it naturally pays to re-pump such a leaky tire and it probably will carry you for a few miles. It is the same with recharged dry cells. If no other power is available, it MAY pay to recharge worn-out dry batteries, but just like a leaky tire, the dry cells will go dead again in a short while.

Let us see why this is so. The standard dry cell is composed of three main elements. Zinc container, electrolyte and depolarizer. The electrolyte which separates the zinc from the carbon manganese depolarizer is usually suspended in blotting paper or special wood pulp paper. When the battery is manufactured, a sufficient amount of electrolyte (usually composed of chloride of ammonium, zinc chloride and other chemicals) is added to the carbon-manganese depolarizer which keeps it moist. In the course of time, this small amount of moisture in the depolarizer vanishes due to the chemical reaction taking place in the dry cell, as well as due to the escaping gases which are formed continuously. All this reduces the action of the battery to a very low point, the voltage falling continuously. Once the so-called dry battery really has become completely dry, the voltage falls almost to zero, because with no moisture present, no more electrical current can be generated.

This, however, is not the whole trouble. For economical reasons, dry cell manufac-

turers through practice have found that if the capacity of a dry battery for intermittent purposes is, let us say, 5 ampere hours, the wall of the zinc container must have a certain thickness. To save weight and money, therefore, the zinc shell is not made any heavier than necessary. Now if commercial zinc were absolutely chemically pure, and if the rolling mill could make zinc sheeting *uniformly* thick, dry cells would no doubt last very much longer, but the price would also be so high that you could not afford to buy one. Therefore, we find that many zinc shells have slight imperfections. See Fig. 1. There are spots which are not uniformly thick, and frequently the zinc contains impurities. At these points, holes develop and the metal is eaten away. The electrolyte leaks out and the defective cell becomes inoperative long before other cells. This is particularly true in "B" and "C" batteries where a number of cells are sealed into one envelope or block, making it impossible to know which cell went out of commission. Of course, one can find out what cell is dead by ripping the block apart, but this is usually a thankless job. If it is done, the dead cell can be shorted by a jumper wire and the result will give you a battery that still may work, although the voltage of the block will be considerably less than what it was when new.

Such a reconditioned battery may last for some time—and it may not. There is no guarantee that more individual cells may not go dead within a few days, but on the other hand, they may last a while. It is a gamble that you take. In any event, there is nothing sure about it, but if the job is undertaken purely for an emergency reason where no other battery or electric power can be had, good and well.

Now as to the so-called electrical recharging business. It is possible to do so although, as we said before, it is not of a great deal of help. Many experiments and much research were made by many battery manufacturers, but in practice the results achieved are hardly worth all the trouble. The usual method is to take the battery block or the batteries, which are hooked up in series, and connect them to the 110 volt direct current. Be sure it is direct current, because if it is alternating, the batteries will be totally ruined. Note that the positive pole of the battery also must go to the positive pole of the current supply. Of course it is necessary to have a resistance in series with the dry batteries, as shown in Illustration No. 2. For a B or C battery, only a very small amount of cur-

rent should be used. You may start in with a 15-watt lamp in series with a line, as shown.

If we have, let us say, a number of No. 6 dry cells, we could use a 25-watt lamp.

How long should the charging current be left on? Anywhere from two to six hours. The smaller the battery, the less the charging time. With a No. 6 battery, six hours with a 25-watt lamp would not be too much.

**Caution:** If you MUST recharge batteries—mind you, we do not recommend the procedure—you have to be watchful. Every hour touch the B or C dry cell block with your hand. If it becomes more than warm, disconnect the charging current. They should never get hot, because too much electrolyte is driven off and evaporated, in that case.

With the larger dry cells such as the No. 6, before recharging them, it may pay to drill several holes through the sealing compound, right down 2-3 inches into the depolarizer, then with a medicine dropper, drop in some fresh electrolyte which is prepared as follows:

Into a pint of distilled water, dissolve 5 oz. of sal ammoniac (ammonium chloride). As fast as the depolarizer soaks up the liquid, keep on refilling until no more can be absorbed. This procedure is sufficient to refresh most of the larger dry cells, and electrical recharging is then not necessary at all. If the batteries are very old and have been almost completely dried out, in that case electrical charging may stir up sufficient chemical action to rejuvenate the batteries a bit more, provided you have filled fresh electrolyte into each cell. Indeed, this is all that electrical recharging ever does. It really does not recharge the battery to any extent, but the ensuing heat and chemical action loosens up the chemicals. It is like whipping up a dead-tired horse who may run another mile and then drop down exhausted again.

It is not suggested that electrolyte be poured into a block of B or C batteries because they are too small, and the conductive electrolyte is likely to short-circuit a number of cells.

What has been said here has reference only to standard dry cells. Cells of the type made by the National Carbon Company under the name of "Layerbilt," and similar types manufactured by other battery manufacturers, cannot be treated in the above manner, for the reason that the construction totally differs from the usual dry cells.

# A METHOD OF LOOKING AT R.F. OSCILLATORS

By MILTON S. KIVER

**T**O many radio men not theoretically inclined, the oscillator as found in superheterodynes, transmitters and signal generators holds untold mysteries. While it is true that the oscillator is not the simplest piece of radio equipment, yet it is not—by far—the hardest to understand. Instead of starting with a completed oscillator and continuing on from there, suppose we start with nothing more than a coil, condenser, and power supply for energy, and build an oscillator around them.

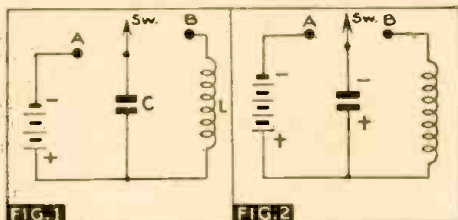

Looking at Figure 1, we find a coil, condenser, battery, and switch. Nothing at all like our every day oscillators, yet before we finish it will be. Flicking the switch over to position A does one thing. The condenser becomes charged to the full potential of the battery. The plate of the condenser connected directly to the positive side of the battery assumes a positive charge and the other side of the condenser is negatively charged. Now put the switch back in its neutral position again. The result of the above is shown in Figure 2. The

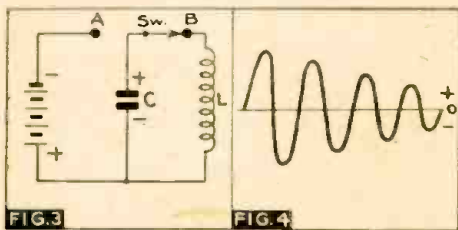

switch is then flicked to position B, completing the circuit between the coil and condenser. The excess electrons on the condenser plate start moving through the coil toward the positive plate of the condenser. These electrons, constituting a current through the coil, cause a field to be built up around the coil. This, however, cannot continue indefinitely, since there is a limited amount of electrons in the condenser. As soon as the current in the coil starts to die down, the field about the coil likewise starts to collapse, tending to keep the current flowing in the same direction (Lenz's Law).

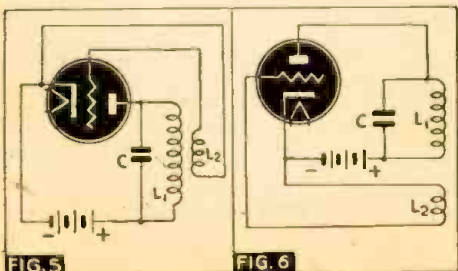

Your condenser is now charged in the opposite direction (see Figure 3) since the excess electrons have moved from one side of the condenser to the other.

The pilgrimage of electrons now starts back again, the field about the coil building up and then, as before, dying out.

These two actions described above constitute one complete cycle of an A.C. wave. The speed with which the cycle will be completed depends not on the amount of charge in the condenser but on the capacity of the condenser and the inductance of the coil. Mathematically the formula is

$$f = \frac{1,000,000}{6.28 \sqrt{LC}}$$

where L is in Henries and C is in microfarads.

Now, there is nothing to prevent the cycle from happening again and again, except one thing. The ohmic resistance in the coil will gradually dissipate all the energy of the condenser until soon no waves will be generated. The process is visualized in Figure 4, and is called damped oscillations. It gradually dies away to nothing.

## PRODUCING CONTINUOUS OSCILLATIONS

Suppose at this point we had some sort of device which would flick the switch over to the battery every time the oscillations started to die down. The condenser would then receive energy necessary to keep the cycles even in amplitude and we would have steady oscillations. Now this would have to be done at the right time else currents would conflict with each other and nothing would be gained.

A mechanical device to do this is out of the question since energy may have to be supplied perhaps a million times a second—something mechanically impossible.

But an electronic device—a tube—suffers from no such limitation. Tubes will respond to impulses occurring much oftener than that. Let us connect this tube between our condenser and battery, as shown in Figure 5. The grid, you notice, is attached to a coil which is in turn inductively coupled to L<sub>1</sub>. Whatever happens in the tank circuit (composed of L<sub>1</sub> and C) will be immediately apparent in the small coil L<sub>2</sub>. And since any voltage induced in L<sub>2</sub> will appear between the grid and the cathode of the tube, the tube will be able to react at the same time. Making the grid more positive will allow more electrons to go through and making it more negative will hinder this action. This electronic switch can thus follow the variations in the tank circuit and keep feeding energy as needed. Steady oscillations will be the result.

And so we have an oscillator. Remember, all the tube does is to keep the oscillations constant. Nothing more. From now on anything we add will be only to make this generator more efficient, but we will not fundamentally change the circuit.

Let us first redraw the oscillator in Figure 5 so that it looks more like what we are accustomed to seeing. Figure 6 shows

the result. The tube now operates pretty close to a Class-A amplifier. We can get much better efficiency if we operate this tube Class-C, and in order to attain this end we shall insert a grid condenser and grid leak resistor. (See Figure 7.)

In order to get better operation and increased output, we should by-pass the R.F. around the battery. This will not only allow more R.F. to appear across the tank circuit but it will also add to the stability of the oscillator. A variable tuning condenser will

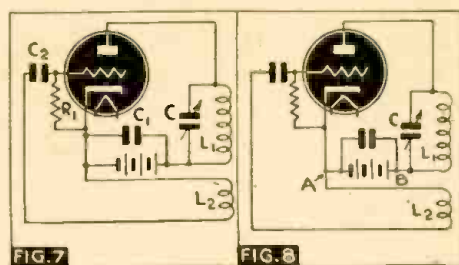

enable us to change frequency at will. All these changes appear in Figure 7.

And so, starting with nothing more than a simple coil and condenser arrangement, we have finally ended up with a tuned-plate oscillator. As we added each part we noted its function and the effect on the final product—oscillations.

This process can be extended to bring in other common oscillators, the Hartley, the E.C.O., which is a form of the Hartley, the Colpitts and most of our other types.

Let us take the Hartley, for example. At first glance it might seem different, having only one tapped coil, instead of two. But taken apart, it shows up as our tuned-plate oscillator just now described. Here is the analysis.

Let us take a look at Figure 8. The two points A and B are at the same potential as far as R.F. is concerned. Why? Because the R.F. at point B loses nothing in going to point A through the bypass condenser. And since all we have across L<sub>2</sub> is R.F., couldn't I just move the wire of coil L<sub>2</sub> from A to B? Doing this gives me Figure 9. And, furthermore, couldn't I now take L<sub>1</sub> and L<sub>2</sub>, combine them, put one tuning condenser across them and still have essentially what I had before? Of course I could. And so, looking at Figure 10, with all these changes gives us the good old Hartley.

In the Colpitts we have only replaced the tapped coil and condenser of the Hartley with a tapped condenser arrangement (Continued on page 634)

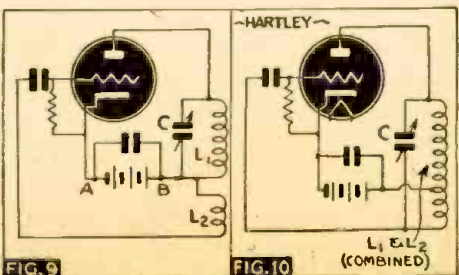

# CROSS-MODULATION AS A FACTOR IN INTERFERENCE

By TED POWELL  
PART I

SOME eight or nine years ago, a rather baffling type of radio interference was first noted by European radio men. It has since been studied and analyzed in this country, and some of its causes and effects described in radio literature. However, for some inexplicable reason it has remained in the background and has always been more or less a nuisance problem to radio men unfamiliar with the theory underlying this interference phenomenon.

It is the purpose of this paper not only to present the work of earlier investigators and the known existing facts, but also a few new angles, both theoretical and experimental, which may throw some additional light upon the subject. It will also emphasize the fact that the problem may at times be rather complex in its nature.

Before going into this type of interference, now known as external cross-modulation (e.c.m.), a very brief resume of elementary theory will be glossed over here as a preface to what is to follow later:

First of all, it must be remembered that in radio work, terms such as "ground", "shield", "filter" and so on, are purely relative factors and in practice do not exist as absolute quantities.

## DOES THE GROUND EVER BEGIN?

Thus, there actually is no such thing as an absolute or true ground in the usual sense of the word. In the case of electrical circuiting, what may be a near-perfect ground at power frequencies or in a D.C. system, may behave as a counter-poise antenna or even as a passable loaded antenna at r.f. levels. Any "grounded" conductor of appreciable length which exists in any radio network will possess an appreciable instantaneous potential gradient with respect to the earth below it because of the appreciable impedance it will have at radio frequencies. This explains why a radio receiver's ground and antenna leads can often be interchanged without much loss in reception.

Even the earth itself is not a fixed or constant ground. The conduction, dielectric and magnetic characteristics of various areas and strata of the earth's solid shell not only differ from each other but vary in themselves as well. Furthermore, variable potential gradients exist within them which cause various types of circulating currents to flow in the earth's shell. Some are of natural origin, some due to human agencies, some are A.C., some D.C. and may be a conduction type, an electrolytic-ionic type or else some combination of these types.

The natural origin of the variations of the earth's magnetic, conduction, dielectric and current characteristics can be found in the activities of the sun. Weather changes effect changes in moisture and temperature conditions which cause variations of dielectric and conduction characteristics. Solar storms cause an increase in the ionic bombardment of the upper stratospheric belts. This results in the creation of stratospheric ionic current streams, disturbances of the Heaviside Layers, changes in the earth's magnetic field, the creation of magnetic

storms, generation of induction current streams in the earth, etc., all of which can combine to produce freakish reflection, refraction, absorption, phase delay and interference effects upon communications systems. The general physical contours and the presence of magnetic and mineral deposits in the earth's surface also have effects upon radiation fields set up by radio transmitters.

## DOES SHIELDING OR FILTERING EXIST?

As for shielding, it might be simply said that there is no known insulator against magnetic flux. Multiple-walled super-permeability alloy shields can be made to produce shielding ratios of up to 5,000 or so. However, *no amount of shielding will completely block off magnetic flux.*

A similar statement can be made concerning filtering. No amount of inductance and capacity will completely block off one circuit's variable potential from an adjacent network. This is particularly true where high frequencies are concerned because of unavoidable stray circuit constants, especially stray capacitance.

There are several other simple radiation and circuiting factors which operate at R.F. levels to make possible various types of interference. Speaking in an elementary sort of fashion, they are as follows: electromagnetic radiation (antenna effect); inductive reactance (choke effect); capacitive reactance (condenser effect); impedance (total A.C. resistance); conduction (direct electronic conduction) and rectification (cross-modulation effects).

Some of these effects increase with frequency to such an extent that at microwave frequencies, a few inches of tubing becomes an efficient antenna, short lengths of conductors become effective chokes, and small conductors lying near to each other make effective by-pass condensers. Impedance effects increase to such an extent that no matter how short or massive conductors may be, they offer appreciable impedance to ultra-short-wave currents. Furthermore, such a thing as a "ground" hardly exists, shielding and by-passing are largely paper terms and conductors lying within or near an ultra-short-wave circuit are "hot",

grounds and shields or no grounds and shields.

One manufacturer's bulletin contains the interesting statement that a one-inch length of No. 10 enameled wire has an impedance of about  $2\frac{1}{2}$  ohms at 3 megacycles. In fact, under certain circuiting resonance and null-point conditions, metal conductors will behave as near-perfect insulators, since there are no dielectric losses involved.

## RECTIFICATION IS THE CAUSE

The rectification and re-radiation effects in which we are chiefly interested here, are largely responsible for the external cross-modulation type of interference or its special case known as "power line hum" or "tunable hum". These will be discussed later in the article.

To generalize briefly, when any interference problem is to be solved, we must consider the radiation, re-radiation, conduction, rectification, capacity coupling and inductive coupling effects between receiver antenna, ground and chassis circuits; power, fire-alarm and telephone lines; building wiring, piping, roofing and steel work; and the various possible combination effects and the phase relationships between these coupling factors.

The various types of interference can be minimized and often eliminated by setting up an elaborate grounding, shielding and filtering systems within the buildings housing the transmitter and receiver systems. This can be accomplished by interlocking all grounds in the building with copper conductors (pipelines, steel beams, metal lathe, roofing, conduit and BX runs, lightning rods, power, telephone and radio grounds, etc.); adding one or two good external grounds; filtering and shielding the power lines feeding the radio equipment especially at the point where they enter the building; eliminating all loose-contact and oxide-corroded rectification joints in radio, power line and building wiring, pipeline and BX runs and any other metallic sections within the building; and finally, where practical, installing shielded power-line filter units directly at interference-producing electrical apparatus.

(Continued on page 632)

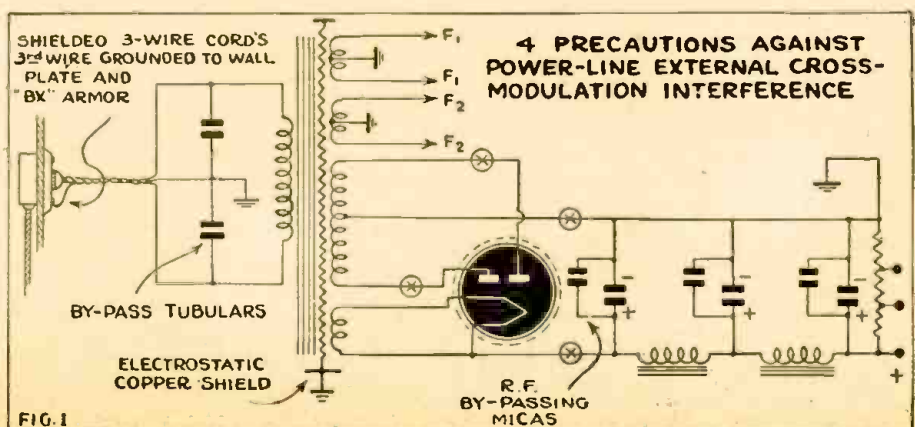

# SOME SOLDERING PITFALLS AND HOW TO AVOID THEM

By ERIC LESLIE

ONE of the beginner's worst problems is the soldered joint. All the instruction books say that joints must be "well soldered" after making sure that the connection is both electrically and mechanically good *before soldering*. He sees the neat, smooth joints of manufactured radios and tries to make his own look the same. This is where his troubles begin. The metal will not "take" solder—it rolls off as fast as he puts it on. His flux disappears in clouds of evil-smelling smoke. When the job is done, it looks like one of those old stereoscope pictures of Niagara Falls in winter. Worse, when he inspects the job, he finds the solder is all attached to one wire, and the other can be moved or turned freely in the "joint." In some cases, his "soldered joint" is a perfect insulator, and instead of lowering the resistance by soldering, he has raised it to infinity!

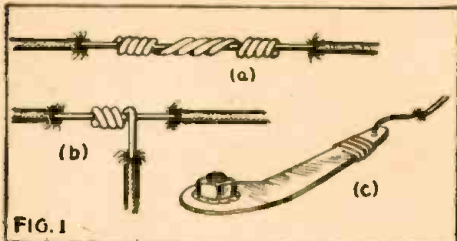

FIG. 1

The chief reason for the beginners' troubles is that little is said in text-books or other places, about the actual process of getting wire and solder together. Authors assume that because they learned to solder so long ago that it seems second nature to them, their students must also have an inherent knowledge of the subject.

This is not the case, as the author knows. Having had some experience with tinsmithing, he had no difficulty with his first radio, and continued to listen to the one-lunger far on into the summer, in spite of the horrible static of the warm season. A neighboring experimenter, however, pronounced the trouble certainly something else than static, which he said sounded entirely different. Investigation showed that the queer sounds were coming from the soldered joints of the set, which, carefully fluxed with muriatic acid, were rapidly becoming non-conductors. The radio had to be torn apart and re-soldered. Then, having learned one of the first lessons in soldering, it was possible to sit down and find out what static really sounds like.

Another newcomer to radio, intent on putting his first set together, was duly warned of the horrors of acid soldering, and impressed with the fact that rosin (or do you prefer resin?) was the only flux

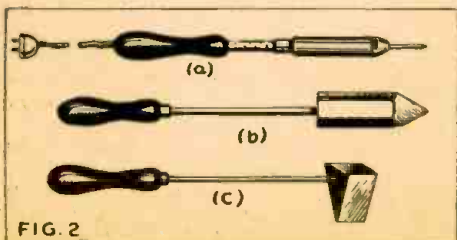

FIG. 2

that should be used. He reported next day that after soldering up his set, reception dropped to zero. Investigation showed not one, but several joints with so much rosin in them that they insulated the wires one from another to such good effect that no current could get through.

So much for what may happen through ignorance of the rules of soldering. Now, what are these rules?

## THE ALL-IMPORTANT RULE

*There is only one rule for successful soldering:* The metal parts to be joined must be thoroughly clean! When solder refuses to stick to a metal surface, it is because that surface is covered with a layer of dirt or oxide. Keep a dull knife and a piece of fine sandpaper handy. Scrape the part till it shines, then polish it up with the sandpaper. Steel wool is a good cleaning medium, if obtainable. As long as there are microscopic specks of unscraped metal surface, there is a possibility of a poor soldering job.

A good cleaning job done on the wire and on the lug or other part to which it is to be soldered, the next step is to make a good connection without solder. See Fig. 1.

The Underwriters' Rules insist that all electrical connections must be perfect mechanically and electrically before soldering. The mechanical part is worth noting. Wires should not be laid side by side, for instance, with the solder used to hold them together, but should be properly spliced first, before solder is applied. Adherence to the rule will pay dividends in the long run, though it may seem unnecessary in many individual cases.

## HOW TO TIN THE IRON

The only really important tool in soldering is the soldering bit, or "iron", (invariably made of copper). To put this in working condition, its surface must be covered with a coating of solder. This process is known as "tinning" the "iron." The beginner's best method of tinning, if he has an electric iron, is to clean it thoroughly with an old file. It can be plugged in and heating while being filed. When it reaches a certain heat, you will note that the bright metal bared by the file immediately darkens, a reddish-brown color spreading rapidly over the surface. Solder will not adhere to this surface, which is oxide of copper. If you rub the surface immediately after filing with a piece of rosin, the metal remains bright. The melted rosin protects the copper from the oxygen of the air. Now, as soon as the iron is hot enough to melt solder, rub a small stick or piece of wire solder all over its surface, leaving a thin layer of solder on it. It is now ready to use.

If you use an iron heated by gas or coal fire, it is necessary to take it off the fire and file it bright, waiting till it is barely hot enough to melt solder before applying rosin and solder. Otherwise the rosin flux will burn up, leaving the iron covered with not only oxide but carbonized flux. Rosin-core solder can be used to good advantage in tinning as well as in soldering, if it is obtainable.

## GOOD JOBS VS. CLOUDS OF SMOKE

Having a clean joint and a tinned iron, you are now ready to start soldering. Here is where the amateur usually makes his second mistake. *Never let rosin-core solder get near a hot iron.* Hold the iron on the joint, and as the wire temperature rises, apply the end of your wire of solder to the joint, watch the rosin melt and run out, fluxing the joint, then the solder melt and run into the joint after it. Hold the iron on till the solder has penetrated thoroughly. You will find that you have done a professional job, (unless you have used too much solder). See Fig. 3.

If rosin-core solder is unobtainable, rosin is applied to the joint and melted in. Solder can be applied to the joint or melted onto the iron and applied. The wire or other surface *must be hot enough to melt the solder*, or you will get a "plastered" joint with the solder not really attached to the metal. As you become proficient you will find that the solder itself can be used to conduct heat from the iron to the parts being soldered.

In soldering large pieces of metal, such as chasses, it may be found that the metal carries the heat away very rapidly, so that it is difficult to get it hot enough to work on. The temptation to do a little "plastering" should be resisted. Get a bigger iron! A large plumber's soldering bit should be kept in reserve for just such emergencies. It can be heated on the gas stove, or with a blow torch or coal fire.

## TECHNIQUES FOR SPECIAL METALS

So far we have spoken of soldering copper with ordinary solder. This is made of lead and tin, usually mixed half-and-half (strictly). Strange to say, the mixture melts at a lower temperature than does either pure lead or pure tin. Copper, tin, zinc and brass have a natural affinity for this alloy, and can be soldered very easily, with rosin as a flux to prevent oxidation. Some radio parts are nickel or cadmium-plated. These metals do not care to associate with ordinary solder, and must be carefully scraped and sandpapered off before soldering to the metal below.

Iron cannot be soldered with ordinary solder and rosin flux. It is usual to flux iron with a solution containing zinc, which makes it easy to solder. A commercial paste recommended for soldering iron may be used. Since iron will be encountered only in non-electrical soldered joints, and usually

(Continued on page 631)

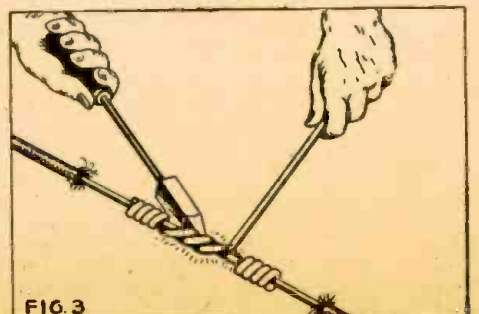

FIG. 3

# WARTIME R.F. COIL DESIGN

By FRED SHUNAMAN

**T**WENTY years ago everybody wound his own coils. Everybody had his pet formula, and anyone could tell at a glance whether or not a given coil would cover the broadcast band with the "23-plate condenser" of the time. Now home construction has been largely superseded by manufactured sets for the broadcast band, and by ready-made coil kits for the short wave experimenter. A generation has grown up which takes its coils for granted, and is at a loss now that factory replacements and coil-kits are no longer obtainable.

Some hints on substituting coils and on cut-and-try methods were given in the December issue (War-time Repair). Sometimes these methods cannot be used, and it is highly desirable to be able to calculate a winding closely enough to bring it at least within the cut-and-try range. A knowledge of coil calculation is useful in checking ex-

perimental results, and a grasp of the principles underlying coil design is helpful in identifying and roughly estimating the range of unknown coils, as is often necessary when confronted with a radio of foreign manufacture.

fore reaching the end of it, and if you put a two-miler on a half-mile track, he will make pathetically low speed. It is necessary to fit the inductance track to the speed (frequency of the signal to be received). In radio this is usually done by changing coils for wide differences of frequency, and using a variable condenser to cover the smaller variations inside a given "band".

## THE SINGLE-LAYER SOLENOID

This was not always the case. The most popular radio of 1923 used variable inductances both for tuning and for regeneration, and the "variometer," or continuously variable inductor, did not go out completely till the superheterodyne made obsolete most of the circuits which had previously used it.

$$L = \frac{.0395 a^2 N^2 K}{l}, \text{ where}$$

L = Inductance in microhenries.

a = radius of the coil.

N = total number of turns on coil.

l = length of coil.

K = a number which corrects the formula for different shapes of coil forms, and depends on the ratio of length to diameter. Values of K are given in Fig. 2.

This formula comes from the Bureau of Standard Circular No. 74, and is the basis for most coil-calculation methods.

All the measurements are given in centimeters, but later we will find a way to reduce them to inches. To see just what these dimensions are, let us look at Fig. 1, which shows a typical coil.

Meanwhile, centimeters may be reduced to inches by dividing by 2.54 or multiplying by 0.394. If dimensions are in inches and you want to put them into centimeters, just multiply by 2.54.

In order to understand these figures, let us first take an example. Suppose we want to wind a coil 2.54 cm. long (1 inch), 2.54 cm. in diameter, (a = 1.27) with wire of

a size that will give us just 100 turns in the 1-inch length (No. 31 enamel). Our formula will then read:

$$L = \frac{.0395 \times 1.27^2 \times 100^2 \times .688}{2.54}$$

$$= \frac{.0395 \times 1.5 \times 10,000 \times .688}{2.54}$$

$$= \frac{407.6}{2.54} = 160 \text{ microhenries}$$

which you will find close to the actual inductance if you try it.

## WHAT THE FIGURES ARE ALL ABOUT

In order to use the formula intelligently,

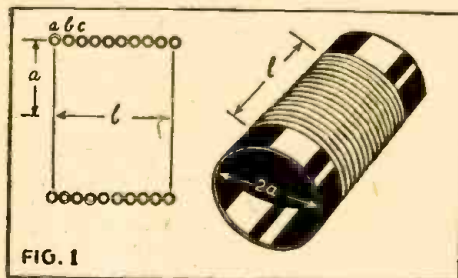

FIG. 1

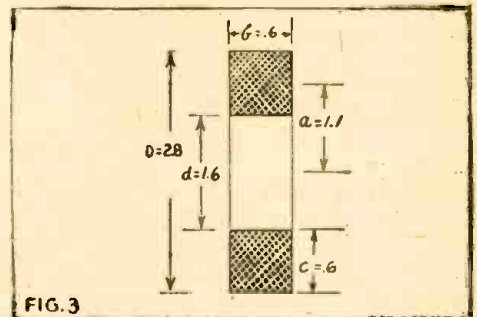

FIG. 3

we should know a little about what it means. To begin with, .0395 is a constant which harmonizes our desire to measure in centimeters and get our answer in microhenries. If we measured in inches, we could use the constant 0.1 which is an easy figure to work with and gives results very slightly larger than those of the standard formula.

The coil's inductance also increases according to the size of the magnetic field set up. This is proportional to a<sup>2</sup>. As to N<sup>2</sup>, let us look at the three first turns of Fig. 1. These are lettered a, b and c. If turn a has an inductance of 1, winding on turn b would certainly increase it to 2, as the second turn should have as much inductance as the first. But b is threaded by the field set up around a and a is in the field set up by b. The inductive effect is due to the magnetic field set up, so the 2 wires will now have 4 times the inductance of 1. Add wire c and you see an inductance of 3 due to the self-induction of each turn, and an inductance of 6 due to the action of each turn on the other two, or a total of 9. The inductance thus increases as the square of the number of turns.

This is not exactly true, as a, b and c are spread out over three times the space that a occupies, therefore the field around a is not as intense at c as it is around its own turn. If we could wind the three turns with wire of 1/3 the thickness, it would be true. As it is, the inductance of a coil of a certain number of turns decreases as the length of the coil increases. Therefore the divisor 1, (length). K, as previously stated, is a factor which compensates for the different shapes in which single-layer cylindrical coils can be wound. The formula was calculated on the

(Continued on page 630)

perimental results, and a grasp of the principles underlying coil design is helpful in identifying and roughly estimating the range of unknown coils, as is often necessary when confronted with a radio of foreign manufacture.

## WHY COILS ARE NECESSARY

To start—as seems necessary—at the beginning, we all know that coils put inductance into a circuit. Inductance is that quality a wire has which causes it to slow down the flow of current through it when a voltage is applied, or to oppose the dying down of the current when the voltage is taken away. This property is due to the magnetic field built up around the wire by the rising current, and collapsing when the voltage is removed, as explained in previous articles (Lenz's Law).

Because the effect of inductance is to slow the rise and fall, it causes a lot of trouble to rapidly alternating currents. The more inductance in a circuit, the lower frequency A.C. that can pass through it without considerable difficulty. Therefore, the inductance must be adjusted to suit the frequency to be passed. The classic example is that of a race course—if you have a course two miles long, a half-miler would play out be-

VALUES OF K			
Diameter	K	Diameter	K
Length		Length	
0.00	1.000	1.50	0.595
.05	0.979	1.75	.558
.10	.959	2.00	.526
.15	.939	2.50	.472
.20	.920	3.00	.429
.25	.902	3.50	.394
.30	.884	4.00	.365
.40	.850	5.00	.320
.50	.818	6.00	.285
.60	.789	7.00	.258
.70	.761	8.00	.237
.80	.735	9.00	.219
.90	.711	10.00	.203
1.00	.688	25.00	.105
1.25	.638	50.00	.061

Fig. 2

# *Today this flag flies over*



From this world headquarters for radio-electronic research flow new weapons, new discoveries and inventions vital to the winning of an Allied victory!

**T**ODAY, over RCA Laboratories, flies a new distinguished battleflag—the coveted Army-Navy “E” Award.

One of the few laboratories in America to receive this award, RCA is at once proud of this distinction, and humbly aware of the responsibilities that it imposes. For much of the progress of the entire radio-electronic industry stems from the work done in these laboratories.

It was perhaps with this thought in mind that—at the dedication of the RCA Laboratories in Princeton—the Chief Signal Officer of the Army called them “The Hidden Battlefront of Research.”

**HIDDEN**—because, for the duration of the war, this magnificent building of 150 separate laboratories must be closed to all but the scientists and research technicians who are working on radio-electronic instruments important to our military effort.

**BATTLEFRONT**—because in the waging of modern warfare, radio-electronics is of first importance. It follows the flag and the fleet—locates the enemy—flashes urgent orders—safeguards the convoy—guides the bombers—directs the artillery—maneuvers the tank. This science fights on every front.

And when that certain day of Victory comes, RCA Laboratories will be devoted to the happier task of making our peacetime world richer, safer, more enjoyable and more productive—through new and finer products of radio, television and electronic research.

## OTHER SERVICES OF RCA WHICH HAVE EARNED OUR COUNTRY'S HIGHEST WARTIME AWARDS



The Army-Navy “E” flag, with two stars, flies over the RCA Victor Division plant at Camden, New Jersey.



The Army-Navy “E” flag, with one star, has been presented to the RCA Victor Division at Harrison, New Jersey.



The Army-Navy “E” flag, with one star, also the U.S. Maritime Commission “M” Pennant and Victory Fleet Flag have been awarded to the Radiomarine Corporation of America in New York City.

*A Service of  
Radio Corporation of America*



# RCA

## WORLD HEADQUARTERS

RADIO-CRAFT for JULY, 1943

*America's Secret Battlefront*  
**RCA Laboratories**



*Laboratories*

**FOR RADIO-ELECTRONIC RESEARCH**

RADIO-CRAFT for JULY, 1943

# CARRIER COMMUNICATIONS

## PART III—AN A.C. TYPE R.F. INTERCOMMUNICATOR

By WERNER MULLER

**H**AVING covered the simplest form of R.F. Carrier device, the A.C.-D.C. type, the next step is to a more advanced design.

This apparatus is not only more advanced—it is the outstanding form of unit available. It covers practically all applications to which it might be adapted and does this with ease. Of course there are limitations, but they are few. The following outstanding features can be claimed for it. (These claims hold good for average conditions.) When the unit or units (two are required for communication) are used in buildings of the larger type up to 24 stories, they will perform without difficulty. No special bridging circuits are necessary. The transmitted carrier will follow the powerlines and will feed through distribution transformers up to 100 KW. This was performed in Philadelphia in 1937. Conversations were carried on, and orders given under conditions as described. Volume and clarity were excellent.

When the units were used in rural districts, any distance within 7 miles was covered, providing the lines were from the same sub-station. Line transformers had little effect on the operations. Up to three miles were covered on iron fences. By slight changes in the output coupling circuit, the units were adapted for use on telephone lines. The lines used were of various types such as lead-covered cables, telephone lines overhead, telephone lines underground, iron wire and copper wire types, transposed lines, co-ax lines etc. The actual

distances covered were amazing. At the start of the tests only a few miles were possible, but noting certain effects, changes were made in transmitter frequency and transmitter termination. The changes gave results which were astonishing.

### LONG-DISTANCE WIRED-RADIO WORK

On a straight telephone line running from Tulsa, Oklahoma to Paul's Valley, Oklahoma (near Texas border) excellent conversations were carried on, far superior to the actual telephone conversation. The distance was 175 miles. This was without repeaters or boosters. Actually two conversations took place, namely the telephone line and the superimposed carrier.

These results can be duplicated any time with the unit described in this article. The diagram is self explanatory. A number of important points must be remembered, so as to avoid difficulties due to circuit interaction.

The power output is high, about 6 Watts of R.F. Carrier modulated about 60%, at 80% to 100% modulation the output can be increased to about 7.5 Watts. This large amount of power is necessary to overcome troubles encountered in the field of applications. It is also for this reason that good results are obtained under practically all conditions. The output of the units is of the link type about .25 to .75 ohms increasing to about 1.5 to 3 ohms for the telephone lines. The operating frequency is 25 Kc. This is important, since higher frequencies, if used, will reduce the distances covered.

With a 25 Kc. unit, radiation difficulties are rarely encountered on transposed lines, as the effects of radiation are nil for practical purposes. A variable or pure link type output transformer is suggested as the best for all practical applications.

### ADJUSTING THE TRANSMITTER

The adjustment of the transmitter is simpler. As can be seen by the diagram the oscillator is of the electron coupled type. Stability of the transmitter frequency is very good and no drift is experienced once the circuits are adjusted. The following outline should be of help. After tying a 250 milliampere pilot lamp across the transmitter output the unit is turned on. By tuning Capacity  $C_1$  the oscillator frequency is determined. Its range is from 22 Kc. to 40 Kc. By listening to beats on a radio receiver one can approximately determine the operating frequency by tuning in a number of carriers. Tune in about four points, and observe their separation in Kc. After having determined the operating frequency, the output circuit is tuned by  $C_1$ .

Resonance will be obtained when the pilot light across the output circuit lights to maximum brilliancy. When this has been done, talking or whistling into the microphone (P.M. speaker) should cause an increase in the brightness of the pilot light. If this takes place the transceiver is operating properly. If the light dims when speaking or whistling into the microphone then the transmitter is not functioning properly.

(Continued on page 635)

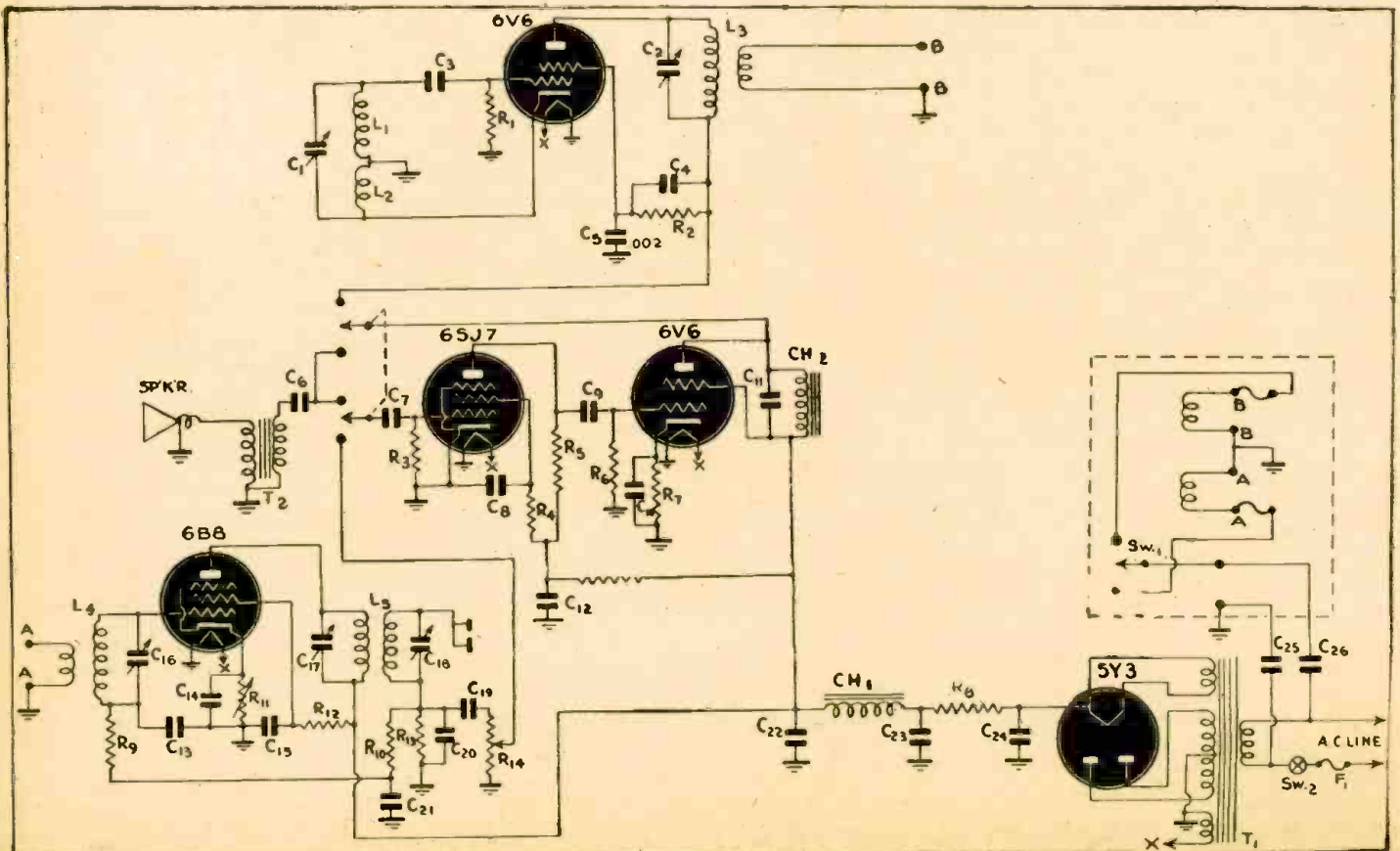



# A SERIES OF ALTERNATING CURRENT EXPERIMENTS

By J. H. SHAY

THESE hookups were used in a series of experiments in War Training Courses in the South River High School. Some of them may be useful in other schools, or interesting to the individual experimenter.

We have found out that for experiments of this kind, a good permanent construction including power source is better than the average laboratory hook-up, which is usually somewhat sloppy and entails a good deal of time wasted putting it together. All these projects are breadboard patterns and made as simple as possible. Of course they are not all my original ideas, but we have added new features to some of them, and ironed out the kinks in each one—those little unexpected features that the average book never tells you about.

Sketch A is a circuit used to show reactance to A.C. The parts used are

- L<sub>1</sub>—8 henrys.
- L<sub>2</sub>—1 henry.
- R<sub>1</sub>—15-watt clear electric bulb.
- S<sub>1</sub>, S<sub>2</sub>, S<sub>3</sub>—Single-throw switches.

On D.C., there will be little difference in the brightness of the bulb, whether Switch 1, 2, or 3 is thrown. Of course the inductors should have a fairly low D.C. resistance. On A.C., the light will glow very dimly with Switch 1 thrown, switching in L<sub>2</sub> instead of L<sub>1</sub> will cause it to glow much brighter. Switch 3 will bring it to full brilliancy.

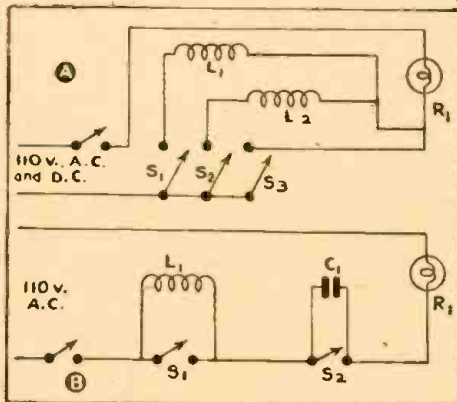

The circuit of sketch B is for demonstrating how the coil and condenser cancel each other out when in resonance. Parts used are:

- L<sub>1</sub>—Iron-core coil.
- C<sub>1</sub>—1-mfd. condenser (paper).
- S<sub>1</sub>, S<sub>2</sub>—Single-throw switches.

(It is a good idea to pick a coil and condenser of as nearly equal reactance to 60-cycle current as possible).

With one of the switches closed and the other one open, the light will hardly glow. It will burn brightly when both are closed. This is a very interesting experiment, as it

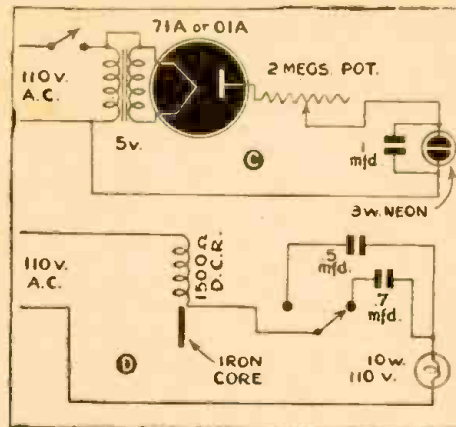

is possible to increase the brightness of the lamp by cutting a reactance into the circuit.

Sketch C is a breadboard setup demonstrating the charging rate of a condenser. All values of parts are given in the text. By changing the voltage with the 2-meg. potentiometer, the charging rate can be varied, as noted by the flashing of the neon bulb, from several flashes per minute to where the condenser is charging and discharging through the lamp so fast as to show a steady glow. This experiment may require a short explanation of the operation of a relaxation oscillator.

The circuit of Sketch D is used to demonstrate resonance in a 6-cycle line. Two sizes of condensers were used to show the different action. One or the other is con-

nected in the circuit by means of a single-pole, double-throw switch, and the circuit brought to resonance by moving the iron core in and out of the coil. This was the secondary of an old inductance coil, common around school laboratories.

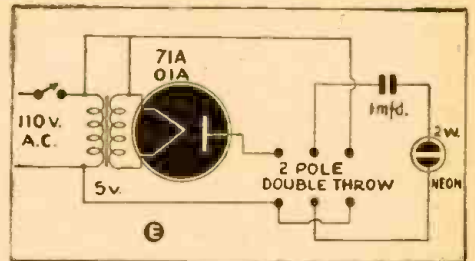

Sketch E. This circuit demonstrates the passage of A.C. and the blocking of D.C. in a line containing a condenser. The neon light will flare up when D.C. is switched on, then go out. Switching to A.C. gives a steady light.

The charging of a condenser is shown in Sketch F. With Switch C and B closed, the condenser charges. With these switches open and A closed, the condenser discharges through the neon bulb.

Sketch F is a simple power supply that may be substituted for the filament transformer operated supply shown in the previous circuits. Results are about equally good with this type of supply, and a transformer is very useful.

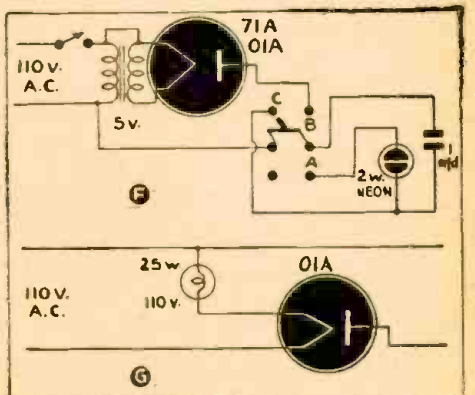

## EMERGENCY POWER SUPPLY

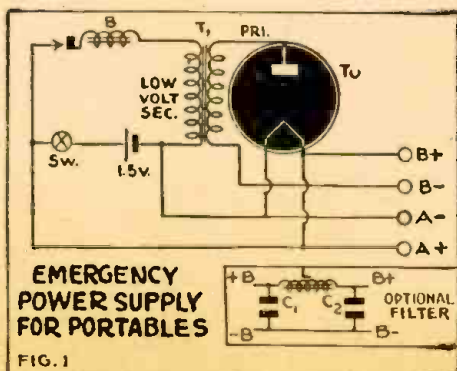

THE diagram shows an emergency power supply for portable radios. The unit can be easily constructed in a half-hour. Although designed for emergency service it makes a good battery substitute on hikes and trips in the summer.

By adjusting the buzzer to a very high note and incorporating the filter unit shown, interference is kept to a minimum.

The unit I constructed (Fig. 1) uses a 1S4 tube as a rectifier, but the experimenter could easily substitute a dry disc rectifier. Since the half-wave units work fairly good, I am at present trying to make it very compact.

Also shown (Fig. 2) is another unit

worth experimenting with. Two tubes, or a full-wave rectifier tube, could well be used here, or a high-voltage dry-disc rectifier.

CHAS. H. MARZELL,  
Brooklyn, N. Y.

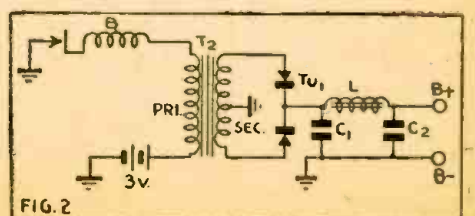

# METERLESS VOLTMETER USES ELECTRON-RAY INDICATOR

By WESLEY NEELANDS

**M**ETERS are scarce—good ones are not available at any price—so here is a meterless vacuum-tube voltmeter.

I use this constantly and find it better than an ordinary voltmeter. It is not only an A.C. and D.C. instrument, but also an output and a.v.c. indicator.

This meter uses only five resistors and four condensers, so any great amount of advice on construction would be out of place. The reader already understands that high-grade components, which will not change their resistance or capacity under load, are necessary in any type of meter.

The power pack may supply any voltage from about 200 to 250. Little filtering is necessary on account of the small current drawn, so the 8 mfd. condenser across the resistor bank will be plenty. The 50,000-ohm volume control should be a heavy-duty type, as it has about one-half watt of power to dissipate.

Excellent insulation is required, especially around the posts to which the prods are connected. If the resistance here should fall as low as 200 megohms, this would mean an error of 5% in readings. This is true of all V.T.V.M.'s, because of their high ohms-per-volt ratio.

## HOW THE METER OPERATES

A word as to the theory may help the beginner. The relative potential of the grid and cathode of the 6E5 control the opening and closing of the eye. This relative voltage can be controlled by making the cathode more positive or negative with the potentiometer  $P_2$ . A closed eye indicates that the grid is negative enough (cathode positive enough) to stop current flow. In practice the bias is adjusted so that the eye is just closed.

The grid of the 6E5 is attached directly to the cathode of the 6C5. (Any low- $\mu$  tube may be used here in place of the 6C5 shown). The cathode resistor is large enough so that no current flows. Now if a voltage—either A.C. or D.C.—is applied between the two input points, the grid will become more positive and current will flow. This will cause a voltage drop across the cathode resistor, and raise the voltage of the 6E5 grid, opening the eye.

Note that the bias can be varied by adjusting either  $P_1$  or  $P_2$ . If the arm of  $P_1$

is at the top (in the diagram) and the arm of  $P_2$  at the bottom, the two are at the same potential. We can change the bias by moving either one. Having already set our voltmeter to the no-shadow point with  $P_2$ , we now compensate for the voltage being measured by moving the arm of  $P_1$  until the eye just closes again.

In other words, we make the grid just negative enough to compensate for or neutralize the applied voltage being measured. Perhaps this example may make the principle clear. To measure the speed of a person walking up a downward-travelling escalator, regulate the escalator until the person is getting exactly nowhere, then measure the speed of the escalator.

## CALIBRATING THE VOLTMETER

This measuring—or calibration—may be done with the aid of a source of several known voltages (say a battery, potentiometer and a good voltmeter), various voltages being applied and the position of  $P_1$  noted. It is an excellent idea to put a long pointer on  $P_1$  and cement a white card to the panel for marking the scales. After the meter is calibrated, the card may be covered with a sheet of celluloid or other transparent plastic.

Note that this will measure D.C. or peak A.C. voltages. To measure A.C. conveniently it is best to have a scale marked out in the standard R.M.S. voltages. This scale may be calculated by multiplying the D.C. or peak voltages by .707. A better method is to calibrate the A.C. scale directly with known A.C. voltages.

## INCREASING THE RANGE

The range of the meter is limited to the amount of drop across  $P_1$ . This should be over 100 volts on the average power supply. For greater range, the usual resistor network may be used at the input. With such a network a certain definite fraction of the voltage to be measured can be applied to the input posts and the voltage measured can be multiplied accordingly. For example, the voltage to be measured may be applied to a 20-megohm resistor consisting of 2 10-meg resistors connected in series. If only one of these resistors is connected across the input posts, only half the voltage to be measured is applied to the meter, and its range is consequently doubled. No diagram of such a network is given, as they are very familiar and to be found on practically all the V.T.V.M. diagrams published in *Radio-Craft* recently.

The process of measuring a voltage with this meter sounds rather complicated, but actually takes less time than it does to describe it. First, you simply short the input terminals (with  $P_1$  in "top" position) for zero adjustment of the eye. Then adjust  $P_2$  until the eye is just closed. The meter is now ready for use. Apply the voltage to be measured. This will cause the eye to open again. Adjust  $P_1$  till the eye just closes, and read the voltage on the calibrated scale under the pointer of  $P_1$ .

The accuracy of your readings depends a great deal upon the care with which the adjustment of  $P_2$  and  $P_1$  are made, as they must be brought to the point of exact closing, and no further.

A cheap and simple electron-ray tube replaces the now unobtainable meter in this useful device. If proper care is exercised in its calibration and use, it should be accurate enough for all radio service applications.

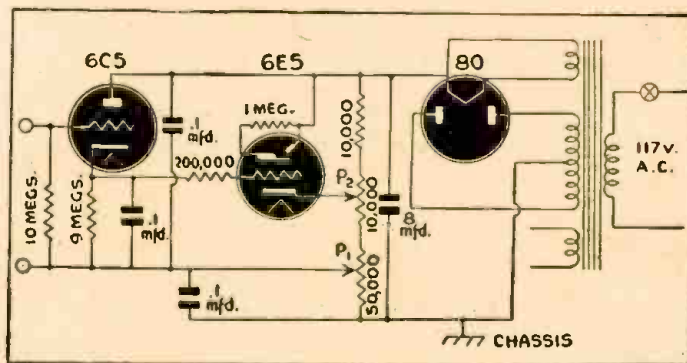

## "AKRON" DETECTED BY RADAR IN 1932

**B**BROADCAST radio waves "bouncing" off the ill-fated dirigible Akron, and their detection by experimental apparatus located inside a truck parked on a Virginia farm, first proved, in 1932, the practicability of what is now known as radar, according to L. A. Hyland, executive engineer of the Bendix Aviation Corporation, whom the Navy in a recent announcement on radar credited with being the first man to prove that aircraft in flight could be detected by radio.

Less than a year before it was lost at sea off Barnegat, N. J., the Akron played its part in the birth of radar, Hyland said, by confirming an important step in the "reflection" theory.

As early as June, 1930, while working for the Navy Department, he observed that

short wave signals being transmitted from a distant spot were not only received directly from the transmitter, but also were bouncing off airplanes in the vicinity and interfering with the direct reception.

The early investigation of this phenomenon disclosed many interesting facts about radio wave propagation. It soon became apparent that any moving metallic object, such as an airplane, ship or automobile, would reflect a radio wave and thus make possible the detection of such objects even at considerable distances.

"One step in the confirmation of the reflection theory," Hyland said, "was to ascertain if any wave would be 'reflected' or 're-radiated' providing the moving object was comparable in length with the radio wave length used. If this supposition

were true, then even broadcast waves would be reflected from a large enough moving structure. That was where the Akron came in."

Hyland mounted his equipment inside a windowless panelled truck and took up a position on a Virginia farm about ten miles from Washington. Here he hoped to be able to follow the course of the Akron, by detecting radio broadcasts from a Washington station as they were reflected from the dirigible.

"With this first set-up I was able to detect the Akron while it was still 30 miles away," he said. "That original equipment was heavy and cumbersome," he added, "a long way from the 'sniffer' that is compact enough to be carried in our modern battle planes."

# The SPRAGUE TRADING POST

EXCHANGE — BUY — SELL

## Your Own Ad Run FREE

The "Trading Post" is Sprague's way of helping radio servicemen obtain the parts and equipment they need, or dispose of the things they do not need during this period of wartime shortages. Send in your own ad today—to appear free of charge in this or one of several other leading radio magazines on our list. Keep it short—WRITE CLEARLY—and confine it to radio items. "Emergency" ads will receive first attention. Address it to:

SPRAGUE PRODUCTS CO., Dept. RC 37  
North Adams, Mass.

**SURPLUS SHOP EQUIPMENT FOR SALE**—Having retired from the service business, I offer a wide variety of equipment for sale for cash. This includes microphones, transformers, rectifier tubes, transmitting tubes, receiving tubes, condensers, relays, meters of many types, and a 5-tube superheterodyne receiver. Write for complete list. Robert W. Wood, 10950 Longview, Detroit, Michigan.

**AMPLIFIER WANTED**—60 to 100-watt or larger, with or without speakers and mike. T. E. Spackman, Monticello, Ind.

**FOR SALE OR TRADE**—2 Triplet 0-1000 volts DC 1000 per volt; 15 Hickok 0-1 Mil. 4 range scales; 1 Clough-Brengle condenser and resistor bridge; 1 triumph A.C. signal generator; 3 battery-operated signal generators; 1 Weston counter-model tube checker; 2 Triplet tube checkers; 1 Dayrad tube checker; 1 Dayrad test panel—4 meters and signal generator—A.C. and D.C. volt ranges to 1600 volts—4 mil. amp ranges—ohmmeter, etc.; Triplet v.o.m. 2000 per volt twin meters; various other volt and milliammeters. Want Smith and Wesson or Colt revolvers and pistols, or what have you? C. H. Finley, R.R.1, Forest, Ohio.

**FOR SALE**—3" Weston meter model 301 0-8 volts D.C., \$4; Weston model 528, A.C. meter 0-15V and 0-150V, \$6.50; Weston 3" meter model 301, 0-5 amp. D.C., \$4. Reuben H. Horn, 274 1/2 So. Rampart Blvd., Los Angeles, Calif.

**WILL SELL OR TRADE**—New Hartman converter 6V D.C. to 110 A.C., about 65 watts; American high voltage transformer Pf-250; 2 SM audio transformers #220-#230; 2 SM Unichokes #331; 2 American audio transformers #678; all in excellent condition. Interested in a late tube tester and manuals. Clifford D. Lessig, Manual Arts Dept., Frenchtown High School, Frenchtown, N. J.

**CASH OR TRADE**—Want good condenser analyzer; also 35Z5, 12SK7, 50L6 Tubes. Have RCA station allocator and Clough-Brengle oscillator. G. R. Roska, 1434 2nd St., N. E., Canton, Ohio.

**WANTED**—Hallcraft receiver SX-28, SX-32, S-20-R. Will pay cash. Roger Lane, Mansion House, Greenfield, Mass.

**FOR CASH OR TRADE**—New Weston thermo-ammeter range 0-5, model 425; Raytheon 3AP1/906-P1 cathode ray tube, like new. Want photo equipment. F. W. Madaris, EM Mcl. 16th Batt. N.T.S., Newport, R. I.

**WANTED** — Volt-ohm-milliammeter; also good signal generator. Will pay cash. Describe in detail and give price. Hurley Ogan, Jr., R.R. 5, Box 24, Clarksville, Tenn.

**M-A METER WANTED**—Need one 0-1 m-a meter in good condition. State price. Sgt. Wm. E. Funke, H.Q. Btry, 74th F.A. Bn., San Rafael, Cal.

**TEST EQUIPMENT FOR SALE**—Hickok model 51X comb. tester and model 17 oscillator, these units mounted in a blue crackle-finish case about 28" x 16" x 7"; also Superior channel analyzer. Want 3" scope or graph, or make best cash offer. John Repa, Jr., Richlandtown, Pa.

**TUBES WANTED AT ONCE**—Types 12SA7 (or GT/G); 70L7GT; 50L6GT. Give prices and quality. Irby Kolb, 319 N. Bainbridge St., Montgomery, Ala.

**FOR SALE OR TRADE**—Triumph tube tester, model 420. Will trade for firearms only. William Nicolodi, Nuremburg, Pa.

**FOR SOUTH PACIFIC USE**—Anxious to buy Echo-phone EC-1 Receiver. Urgently needed. Must be in good condition. Have you one to sell for a boy "over there"? Write T-Sgt. J. E. Grimes, M. C. S. Dept., Quantico, Va.

**FOR SALE OR SWAP**—Crystal Microphone, Shure model 74B spheroid type, ultra wide range. Mike only, less cable and connector, in original carton. Also have Radio and Chemistry laboratory equipment. Write Raymond H. Ives, RT 1c; U. S. Coast Guard; Communications Base, Portsmouth, Va.

**URGENTLY NEEDED**—Electronic multimeter or Rider chanalyst; late model tube tester, and oscilloscope, and signal generator suitable for receiver alignment; also want set of Rider's Manuals. Highest cash price paid. Elwood Carson, 3412 Duk St., Portsmouth, Va.

**WANTED AT ONCE**—Output transformer, universal type, 117N7GT type tube, 2 of each, or a cheap tube audio oscillator for code practice. Will pay cash. Pvt. Jesus F. Flores, 932 T. E.F.T.S., Marfa Army Air Field, Marfa, Texas.

**WANTED**—Recording equipment. dual speed turntable 16"; lead screw overhead cutting mechanism, crystal or magnetic head—500 ohms. Will consider record-changer-recorder. Pay cash or part in trade. What do you need? F. U. Dillion, 1200 North Olive Drive, West Hollywood—46, Calif.

**RIDER'S MANUALS WANTED**—Complete used set or any volume; also need 6 inch slide rule, any good make. Peerless Radio Co., 3721 Geary Boulevard, San Francisco, Calif.

**NEEDED IMMEDIATELY**—Hallcraft's receiver S-20R or S-19R; also Howard 435-A or 436-A. Clay Smith, 606 East Pryor St., Athens, Alabama.

**WANTED**—Hickok model 510X combination 1942 tester. Must be in A-1 condition. Will pay cash. Give full particulars and price. L. M. Burtis, 2333 S. 53rd Avenue, Portland, Oregon.

**INSTRUMENTS FOR SALE**—At pre-war prices: new Million oscillator model Q; new Supreme V.O.M. model 543; two new Supreme tube testers model 589; one new American combination tube tester and V.O.M. model 4102; one new Million V.O.M. model D; one new Supreme frequency modulator 529; also one Philco oscillator and one Clough-Brengle OCA oscillator. Bill Gall, c/o Station WEBQ, Harrisburg, Illinois.

**WANTED**—The following Superior instruments: dynamometer, utility meter, and model 1280 set tester. Have in trade Powers trans. audio trans. 0-1 milliameters, 0-20 A.C. milliammeter and amplifiers. Chester Hyde, 111 North Havar St., Hartford, Mich.

**FOR SALE**—One almost new Philco all-wave signal generator, model 070. Will take \$25. Frank P. Rose, Rose Garage, Glasgow, Md.

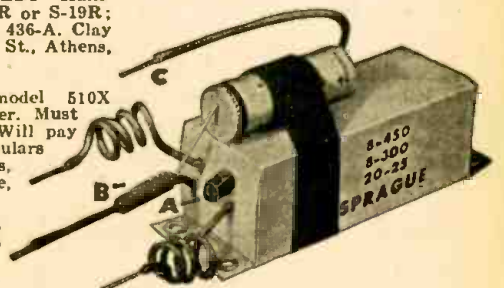

Illustrating how a Sprague Atom Type UT-8 (8 mfd. 450 volt) replaces the 8 mfd. 450-volt section of a 3-section condenser rated at 8 mfd. 450 V.; 8 mfd. 300 V., and 20 mfd. 25 V.:

- (A) Cut lead to defective section and tape end.
- (B) Connect cut circuit lead to positive (+) side of Atom.
- (C) Connect Cathode (-) side of Atom to common minus lead of multi-section condenser.

## HERE'S THE PATRIOTIC WAY TO REPLACE A DEFECTIVE CONDENSER SECTION



When you find one bad section in a multi-section dry electrolytic condenser, don't replace the entire unit! Most defective sections can be replaced by using a Sprague Atom of the proper capacity and voltage, as illustrated here. The Atom can either be fastened by tape to the multi-section unit, or simply held in place by means of its sturdy wire leads. You'll save time and money—and you help conserve essential war materials as well!

Atoms are made in a complete line of capacities and voltages, as well as in many combinations.

SPRAGUE  
PRODUCTS CO.  
North Adams, Mass.

# SPRAGUE CONDENSERS AND KOOLOHM RESISTORS

Obviously, Sprague cannot assume any responsibility for, or guarantee goods, etc., which might be sold or exchanged through above classified advertisements.

# THE LISTENING POST

Edited by ELMER R. FULLER

**R**EPORTS from our readers show that this column is being received with greater enthusiasm than was anticipated, when it was started a few months ago. Several reports have been received during the past month, and we hope that more will be received during the coming months. I would like to hear from every interested reader, and will answer all letters received. Please write to me, care of *Radio-Craft* magazine.

Reception for the past month has been interrupted some by electrical storms, but some very good reception has also made its appearance. A new catch is reported to us by Robert Hoiermann of Alliance, Ohio; an anti-Nazi station calling themselves "Gustav Siegfried Eins" on 9.48 mc. Has been heard about 10 p.m. Another German-

speaking station using the identification of "Deutsche Kurzwellen Sender Atlantic." Sometimes he is on about 6.17 mc. and sometimes about 6.24 mc. This transmitter has been heard every night from 9:30 to 10, 10:30 to 11, 11:30 to 12, and 12:30 to 1. According to their broadcasts, he is also on in the 31-meter band, but has not been located there. We would like to receive further reports on these two stations, and identify them, if possible. (Both of these outlaw stations are actually in Germany.)

Other reports last month were received from James S. Messler, Trenton, New Jersey; Gilbert L. Harris, North Adams, Massachusetts, and Frank Heiss, Cranston, Rhode Island.

HAM DUST—heard on the twenty-meter band, about 8:30 to 9:30 in the eve-

ning by Robert Hoiermann. They include OA4D, CX3CN, ZP2AC, ZP5AC and ZP6AC. It appears that I have developed the theory that reports on amateur stations would not be published, and we are sorry if we made that impression on our readers. It is our intention to publish reports on the hams who are still left on the air, although only a few of them now remain.

If you have any information on stations which we do not publish, send us reports of it. We will be more than glad to receive them. We have had requests that we give both the frequency and wavelength, but very few pay much attention to the wavelength any more, since nearly all receivers are calibrated in kilocycles and megacycles.

Schedules of news broadcasts remain the same as they were in the last issue.

Mc.	Call	Location and Schedule	Mc.	Call	Location and Schedule	Mc.	Call	Location and Schedule
26.5	—	RIO DE JANEIRO, BRAZIL; Radio Nacional; nightly to N. A.	15.250	WLWO	CINCINNATI, OHIO. Latin-American beam, 5:30 to 7 pm.	11.84	VLG-4	MELBOURNE, AUSTRALIA. S. E. Asia.
21.63	WNBI	BOUND BROOK, NEW JERSEY.	15.230	VLG-6	MELBOURNE, AUSTRALIA. 9:40 to 11:50 pm, 11:55 to 7 pm.	11.84	—	MALAYA. "Radio Shonan." Controlled by the Japanese.
21.59	WGEA	SCHENECTADY, NEW YORK.	15.230	—	USSR. 5:15 to 5:40 pm, 6:50 to 7:25 pm, 9:15 to 9:40 pm, 11:15 to 11:40 pm.	14.830	WCRC	BRENTWOOD, NEW YORK. Latin American beam, 7:30 pm to midnight daily.
21.57	WCBX	BRENTWOOD, NEW YORK.	15.210	WBOS	BOSTON, MASS.	11.83	VLI-12	SYDNEY, AUSTRALIA.
21.54	WBOS	BOSTON, MASSACHUSETTS.	15.220	—	"VOICE OF FREE INDIA." 10 am to 12:05 pm.	11.830	WCDA	BRENTWOOD, NEW YORK. European beam, 6 am to 6:30 pm daily.
21.52	WCAB	PHILADELPHIA, PENNSYLVANIA.	15.220	—	"NATIONAL CONGRESS RADIO." 12:15 to 12:53 pm.	11.800	JZJ	TOKYO, JAPAN. 7 to 9:30 pm.
21.50	WGEA	SCHENECTADY, NEW YORK.	15.200	DJB	BERLIN, GERMANY. North American beam, 5:50 pm.	11.790	WRUL	BOSTON, MASS. 5:15 pm.
21.46	WRUL	BOSTON, MASSACHUSETTS.	15.200	XGOY	CHUNGKING, CHINA. Asia-Australia—New Zealand beam, 6 to 8:30 am; East Russia beam, 6:30 to 7 am; Japanese beam, 7 to 7:30 am.	11.785	OIX3	LAHTI, FINLAND. 9:15 am.
20.040	OPL	LEOPOLDVILLE, BELGIAN CONGO.	15.19	OIX4	LAHTI, FINLAND. 9:15 am.	11.770	DJD	BERLIN, GERMANY. 5:50 pm.
18.54	—	MOSCOW, USSR.	15.17	TGWA	GUATEMALA CITY, GUATEMALA. Daytime transmissions.	11.76	TGWA	GUATEMALA CITY, GUATEMALA.
18.48	HBH	GENEVA, SWITZERLAND.	15.155	SBT	MOTALA, SWEDEN. 12 to 2:15 pm.	11.78	GVU	LONDON, ENGLAND. 6:30 to 6:45 pm.
18.45	HBF	GENEVA, SWITZERLAND.	15.150	WNBI	BOUND BROOK, NEW JERSEY. European beam, 8 am to 5 pm daily.	11.73	CJRX	WINNEPEG, CANADA. Sundays 10 am to 12 midnight, daily 7:30 am to 1 am, Saturdays 7:30 am to 2 am.
17.915	CR781	LOURENCO MARQUES, MOZAMBIQUE.	15.129	—	ATHLONE, IRELAND. "Radio Eireann." 2:30 to 5 pm.	11.71	VLG-3	SYDNEY, AUSTRALIA. North American beam.
17.910	—	MOSCOW, USSR.	15.110	—	USSR. 5:15 to 5:40 pm, 6:50 to 7:25 pm, 9:15 to 9:40 pm, 11:15 to 11:40 pm.	11.71	WLWO	CINCINNATI, OHIO. European beam, 1:15 to 5:15 pm.
17.850	PRL8	RIO DE JANEIRO, BRAZIL.	15.105	JLG4	TOKYO, JAPAN. 7 to 9:30 pm.	11.705	SBP	MOTALA, SWEDEN. 12 to 2:15 pm.
17.840	—	ATHLONE, IRELAND. "Radio Eireann." 8:30 to 9:30 am, 1:30 to 2:15 pm.	14.925	PSE	RIO DE JANEIRO, BRAZIL. North American beam, daily 7 to 8 pm.	11.705	CBFY	VERCHERES, CANADA. 7:30 am to 11:30 pm.
17.830	WCBX	BRENTWOOD, NEW YORK.	12.455	HCJB	QUITO, ECUADOR. "La Voz de los Andes" (The Voice of the Andes) in English daily at 8 am and 6 and 9 pm. At other times in Spanish.	11.68	GRG	LONDON, ENGLAND. 5:15 to 7:15 pm.
17.830	WCRC	BRENTWOOD, NEW YORK.	12.11	TPZ	ALGIERS. 1 to 5:30 pm.	11.623	COK	HAVANA, CUBA. 3:30 pm.
17.8	WLWO	CINCINNATI, OHIO. European beam, 10 am to 1 pm.	12.97	PPH	BRAZIL. 5:45 to 6:15 pm.	11.6	—	RUMANIAN FREEDOM STATION. 1:45 to 1:55 pm, 4:15 to 4:25 pm.
17.800	TGWA	GUATEMALA CITY, GUATEMALA.	11.893	WRCA	BOUND BROOK, NEW JERSEY. European beam, 1 to 4:45 pm, 4 to 8:45 am; Latin American beam, 5 to 11:30 pm.	11.37	—	CROTIAN FREEDOM STATION. 2:30 to 2:40 pm.
17.780	WRCA	NEW YORK CITY. European beam, 9 am to 12:45 pm.				11.150	PRL8	RIO DE JANEIRO, BRAZIL. Afternoons and evenings except Sundays. Off at 11 pm.
15.980	AFHQ	ALGIERS; 8 to 9:45 am.				10.543	DZD	BERLIN.
15.850	WCW	European beam, 6:45 to 9 am. 5:15 to 6:15 pm.				10.525	VLN-8	SYDNEY, AUSTRALIA. North American beam.
15.750	—	MOSCOW, USSR. North American beam, 9:15 to 9:30 am.				10.100	WJQ	Australian beam. 7:15 to 8 am.
15.430	—	ACCRA, GOLD COAST. Heard testing at 2:20 pm.				9.905	WRX	WEST SOUTH AMERICAN beam, 8 pm to midnight.
15.350	WRUL	BOSTON, MASSACHUSETTS. European beam, 9:15 to 9 am.				9.835	—	? FREEDOM STATION. 2:15 to 2:27 pm, 7:15 to 7:27 pm; speaks German.
15.345	FGA	DAKAR, SENEGAL. 3:15 to 5:20 pm.						
15.315	VLI-3	SYDNEY, AUSTRALIA. S. E. Asia beam.						
15.270	WCBX	BRENTWOOD, NEW YORK. European beam, 6 am to 4:30 pm. Rio beam. 5 to 7:45 pm.						
			11.87	VLI-2	SYDNEY, AUSTRALIA. British beam.			

(Continued on page 624)

**"TAKE IT EASY SPIKE, AND I'LL LET YOU LISTEN TO MY ECHOPHONE EC-1"**

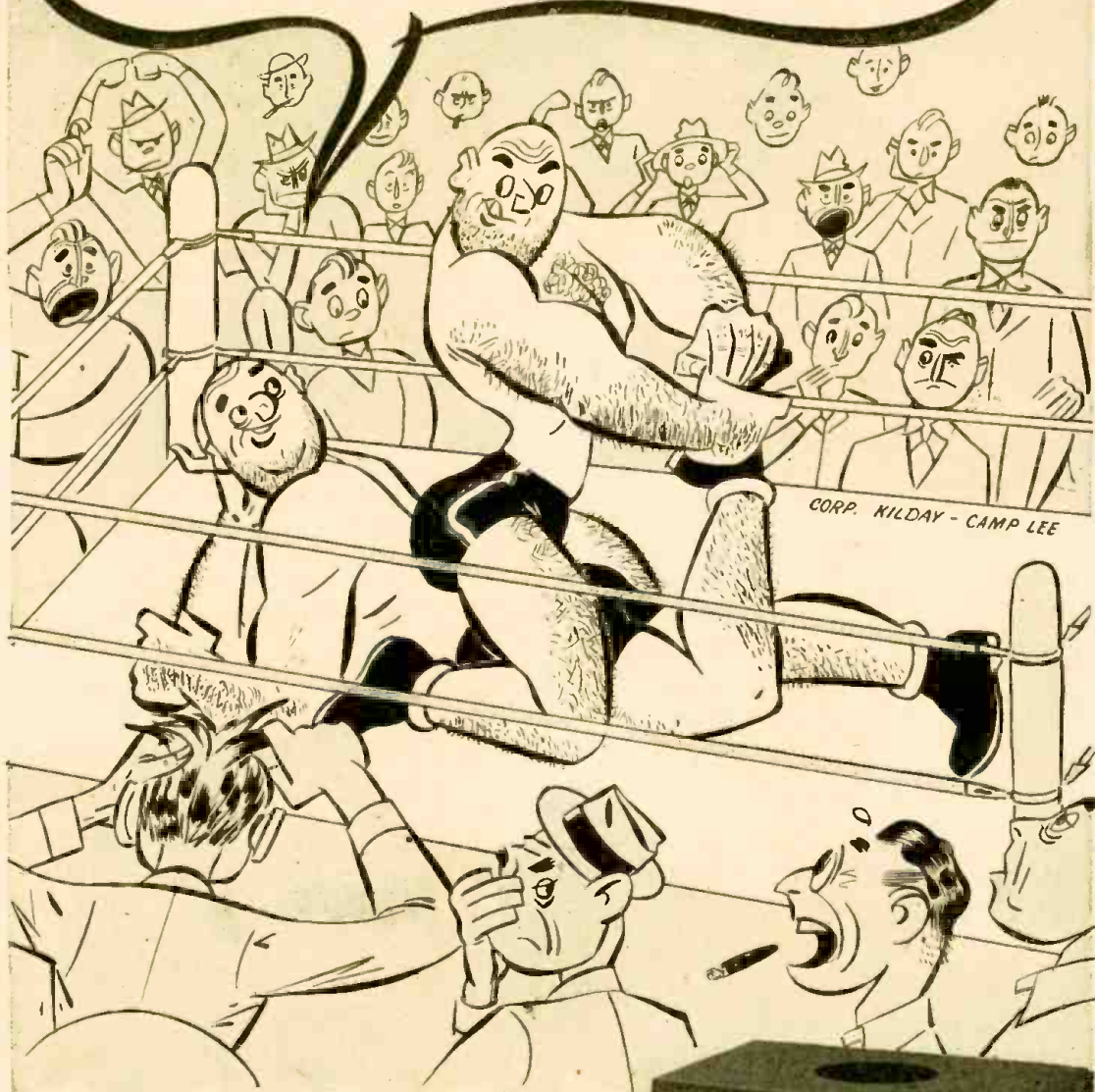

**Echophone Model EC-1-**

(Illustrated) a compact communications receiver with every necessary feature for good reception. Covers from 550 kc. to 30 mc. on three bands. Electrical bandspread on all bands. Six tubes. Self-contained speaker. Operates on 115-125 volts AC or DC.



**ECHOPHONE RADIO CO., 201 EAST 26th ST., CHICAGO, ILLINOIS**

*Diagrams for*

# THE RADIO EXPERIMENTER

If you have a new Hook-Up, send it along; a pencil diagram will do. Be sure to include a brief description.

All diagrams and descriptions accepted and published will be awarded six-month subscription. Diagrams may be for receivers, adapters, amplifiers, etc. Send them to Hook-Up Editor, RADIO-CRAFT, 25 W. Broadway, New York 7, N. Y.

## U. H. F. OSCILLATOR

The plate and grid lines are  $\frac{1}{8}$  inch soft copper bus or tubing, bent into a circle about 6 inches in diameter. Otherwise the drawing is self-explanatory. R.F.C. should be an ultra-high-frequency type R.F. choke.

Better results can be obtained with D.C. plate supply, but A.C. will work all right. Any triode will do, but for high plate voltages the 45 gives excellent results. If a

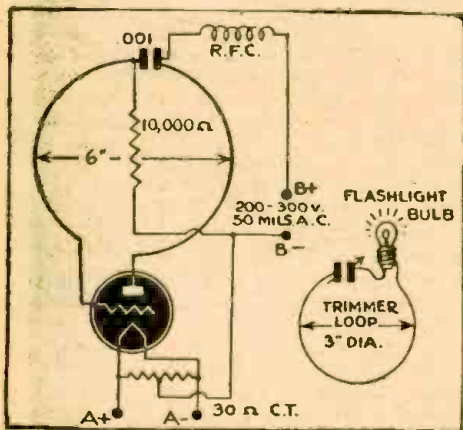

filament transformer is used, R.F. chokes must be inserted in the filament leads.

A small neon tube will glow when brought near the plate or grid line, thus indicating oscillation. A simple tuned circuit with a flashlight bulb—as shown—will also work.

J. STERNFELD,  
New York City

## 1-TUBE TRIODE RECEIVER

Compactness is the keynote of this ultra-portable receiver. The 13½ volts are supplied by three 4½-volt "C" batteries.

The whole set-up may be housed in a large size cigar box (including the batteries).

To obtain greater selectivity (when using a long antenna), a 0.001 mfd. condenser is used in the antenna lead-in.

Standard six-prong plug-in coils are used.

DAVE SPENCER,  
Medford, Mass.

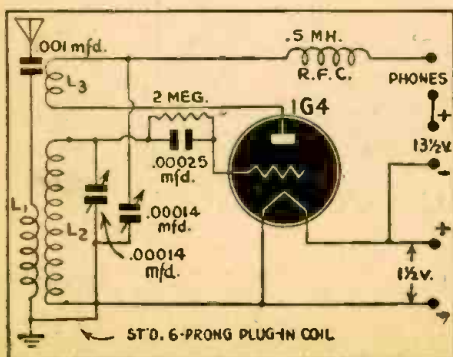

## USE FOR OLD RECTIFIERS

The following circuit illustrates a handy tester for paper by-pass condensers, which uses an old voltage doubler tube of the 25Z5 type which has one section burned out, and is no longer fit for radio receiver service.

The original tester, in use by the author, has performed nicely. We have found it to be fairly accurate for testing the value of a condenser.

A good condenser gives one or two flashes on the neon bulb. A shorted one makes a continuous flash; and one with high leakage gives a series of flashes, close together.

Both cathodes are tied together, and the plates likewise, so that the circuit will work if the tube is replaced with the opposite section burned out or open.

CLARENCE J. TABER,  
Bluefield, Va.

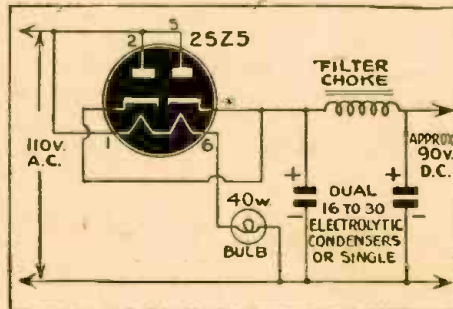

## SHORT WAVE ADAPTER

The coils used in the converter are of the plug-in type which are used in short-wave receivers.

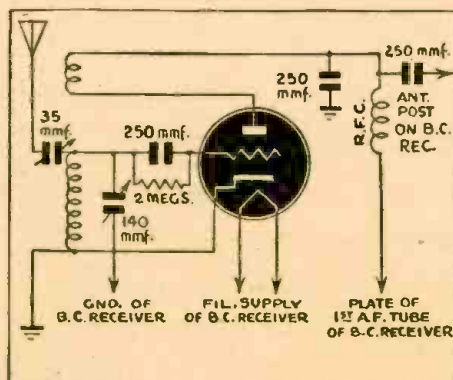

Type 27 or 56 tubes are used in the converter when the broadcast receiver uses the 2.5 volt tubes, and type 37 is used when the receiver employs the 6.3 volt type.

The filament and plate voltages are secured by connections made to the prongs of the receiver tubes, therefore it is not necessary to build a separate power supply.

D. J. CRUICKSHANK,  
St. Johnsbury, Vt.

## FORD COIL RECTIFIER

Looking through an old issue of *Radio and Television*, August, 1940, I came across plans for a power supply using a Ford ignition coil. I wanted a power supply of this sort, but did not have the tube (BA or BH type) shown in the diagram.

Since this tube is old-fashioned and hard to obtain, I substituted an 84 tube (of the heater cathode type) and received good results.

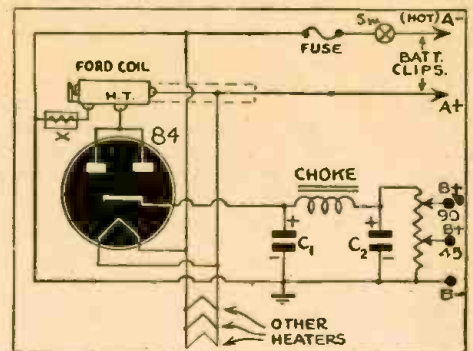

The diagram might be of benefit to other readers.

EDWARD HELDT,  
Rockaway Beach, N. Y.

## CHRISTIE FEEDBACK OSCILLATOR

The "Christie Feedback" consists of running an insulated wire between two I.F. transformers of a receiver, and through the holes in the tops of the transformer cans, so that about a half-inch of wire hangs down inside the shielded cans.

This wire (and the winding of the transformers) acts as a condenser, increasing the inter-electrode capacity of the tube, which oscillates as a T.P.-T.G. oscillator, and beats with the incoming signal, to produce an audible note in the speaker or phones. Selectivity of a broad-tuning receiver may be increased by using just enough wire to cause regeneration.

The advantage of this system is that a receiver with only one I.F. stage can be used, and the only thing necessary is a 12-inch piece of insulated wire.

EUGENE GEORGE,  
Toronto, Ont., Can.

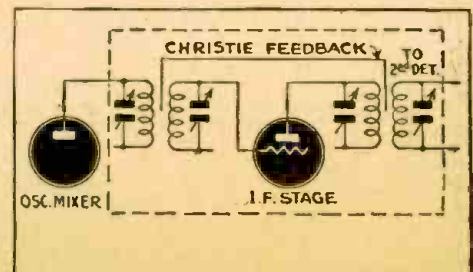

# LETHAL WEAPON

## IN THE WAR ON U-BOATS



**THE NEW SCIENCE OF ELECTRONICS** has profoundly changed the art of war. On land, in the air, above and below the surface of the sea, our forces fight today with electronic weapons of incredible power, speed, precision. It is satisfying to the men of Radio to know that these weapons have proved so successful on every battlefield where our boys, planes, tanks and ships have come to grips with the enemy.

The revelations concerning RADAR and its part in the war came as no surprise to those whose job is to supply our fighting forces with modern electronic equipment. Since before Pearl Harbor these Americans have been working shoulder to shoulder with our armed forces in applying the power of electronics to the art of war. Out of this united effort have come fighting weapons never before known—on land, at sea or in the air. In

this pioneering work it has been National Union's privilege to play a progressively increasing part. A greater National Union has been built to cope with vastly larger responsibilities in the coming "Age of Electronics." To service engineers this is assurance of every complete merchandise. National Union will assist to service

**NATIONAL UNION RADIO CORPORATION • NEWARK, N. J.**

# NATIONAL UNION RADIO AND ELECTRONIC

Transmitting Tubes • Cathode Ray Tubes • Receiving Tubes • Special  
Volume Controls • Photo Electric Cells • Exciter Lamps • Panel

# RADIO KINKS

## LOCATING BREAK

Here is one method of finding an "open" wire in cloth covered cables. Connect a 110-volt lamp of 50 watts or more to each end of the suspected wire.

Twist and pull on cable until position is found where lamp can be flashed rapid, causing an arc at the break. The ensuing smoke will locate the exact spot.

Open the covering with a razor blade,

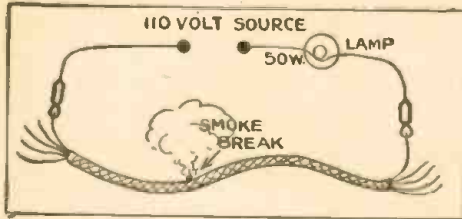

repair, and tape up with cotton or linen tap, which makes a neat flexible job and can be colored to match.

Radio power cords, battery cords and ordinary lamp cords are examples.

E. L. RUSSELL,  
Colfax, Ill.

## HANDY RADIO CHASSIS JACKS

A set of adjustable "jacks" for holding a chassis in position may easily be made from large spools. The type that radio wire comes on are good, the half-pound spools being the handiest. A dowel of the right size to fit is slipped down inside the spool and a hole bored to take a thumb screw as shown. By making a tight fit, the spool itself may be tapped by the bolt so that it can be used for a time. When it slips, a nut can be bedded in the wood from the inside, and it will continue to work. Holes can also be bored in the dowel, and pins slipped through to hold it at various heights.

Several of these spool jacks at convenient points under the chassis hold it upside down without damage to tubes, coils or other parts mounted on the base.

PHILIP LEWIS,  
Hamden, Conn.

Do you have any interesting and novel kinks which you would like to bring to the attention of RADIO-CRAFT readers? If so, send them in addressed to the Kink Editor. A seven-month subscription to RADIO-CRAFT will be awarded for each kink published.

## A PARTY-LINE NECESSITY

This trick works very well at the shack, so I am sending along a description and diagram. It is an easy way of listening in on telephone conversations.

The pick-up coil may be an old Ford spark coil, a field coil from a speaker or any similar high-inductance coil. It is simply laid on top of the telephone box and its connections made to the input of an A.F. amplifier. It is perfectly legal since nothing is connected to the telephone circuit itself.

A one or two stage amplifier should operate a speaker at full volume.

LINDSAY RUSSELL,  
Needham, Mass.

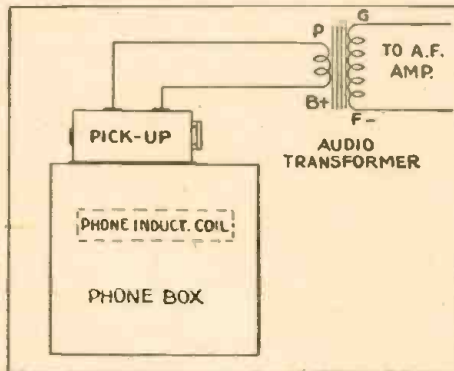

(This takes us back to the days of the single-circuit receiver, when by inserting a piece of paper between the switch arm and the taps it was possible to use the aerial to pick up telephone conversations from the induction field around the outside wires. Possibly this might be listed as a war-time electronic device, as in rural homes equipped with electricity, the necessary party-line listening may be done with the phone on the hook, at a great saving of valuable and hard-to-replace telephone batteries!—Editor)

## TEMPLATE FOR DIAL MARKING

Often the experimenter finds it difficult to mark dials for home-made equipment. When this is attempted free-hand it often results in a splotchy job with markings not running true with the pointer.

I have made the job easy by employing a gadget made of thin metal as shown in Fig. 1. The device should be slightly longer than the pointer on the dial and the marking side should line up exactly with the center of the shaft. The tab at the outer end should be turned up so the marker can be held firmly in position.

To use, remove the dial pointer and drop the marker guide down on shaft, replacing pointer again, as shown in Fig. 2.

Now, suppose you are calibrating some instrument, say an oscillator. After tuning to the exact point on the dial, the guide is brought into exact line with the pointer

and held firmly and then the pointer is moved out of the way and the line marked in.

Main points can be marked with longer cross lines and intermediate points with shorter ones, as shown in Fig. 2.

AUDIE ROBERSON,  
Alex, Oklahoma.

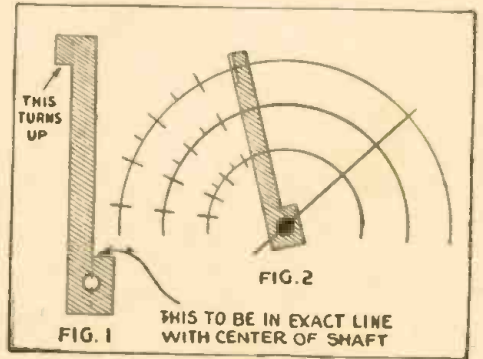

## QUICK OPEN-FILAMENT CHECKER

A frequent cause of failure in A.C.-D.C. radios is the breakdown of tube filaments. I find the little gadget pictured here very useful. It is simply a lamp socket with wire attached and a small 10-watt bulb. (A 25-watt bulb may be used on sets drawing 0.3 ampere.)

Run a bit of solder on the wire ends to stiffen them, then turn on the set to be tested, remove one tube at a time and insert the ends of the wires in the filament holes. When the defective bulb is removed and the wires inserted, the set will light up.

ARTHUR CREAMER,  
Toronto, Canada

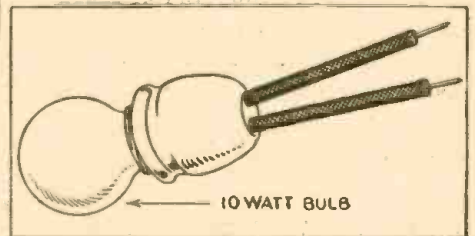

## WAVE TRAPS AND CROSS-TALK

In some cases when cross-talk is bad grounding the A.C. line at the set will clear the trouble. Use a 1-mfd. paper condenser in series with the ground line, and ground the grounded side of the line, as otherwise such a large condenser would cause complications.

With sets using loop antennas, cross-talk and station riding can often be reduced or completely eliminated by placing another loop—tuned to the frequency of the interfering station—adjacent to the set's loop.

LEO G. SANDS,  
San Francisco, Calif.

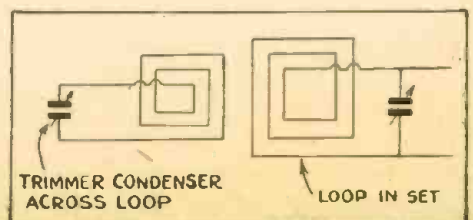





**GRAB YOURSELF A COPY OF THIS BRAND NEW MANUAL BOYS! ITS JAM PACKED WITH DATA, CIRCUITS AND ALL THE SET INFO YOU NEED UP TO DATE OF GOVERNMENT SHUT DOWN APRIL '42.**

*Read These Facts!*

**LOOK AT A COPY NOW**

*See for yourself — COMPARE!*

**MORE LISTINGS:** This 1942 Radio Circuit Manual has nearly 400 more listings than the last edition of a similar manual. Covers receivers manufactured up to time of Government shut down order in April 1942. The set you're looking for here when you need it!

**MORE POPULAR SETS:** Listings of many popular set models are far more complete than in other manual recent edition. Check for yourself on such makes as Lafayette, Emerson, Pilot, Philco, RCA, Stewart Warner. This completeness will save you many times the cost of the book by saving your time enabling you to handle work more promptly.

**PERFECT DIAGRAMS:** There's nothing more annoying or costly than finding an incomplete circuit drawing. An artist carefully checked and retouched every diagram in the Radio Circuit Manual to make sure of PERFECT diagrams. The printing is clear, distinct, complete! You'll enjoy using this manual.

**MORE ON PAGE:** Ever had to fumble around turning pages because complete information didn't appear on one page? The Radio Circuit manual has big roomy pages which permit more complete data on a single page than any other manual. Another time-saver for you.

**HANDY SIZE:** The Radio Circuit Manual is thin, not fat, dumpy and bulky. This thin size and large page size makes it much easier to handle, easier to store

in a minimum of shelf space. The book lies open too, without pages flopping over so you have to hunt for your place again.

**QUICK REFERENCE INDEX:** The index in this manual is complete for both 41 and 42 editions. A big feature is the fact it tells you at a glance if a model is the same as another model number. No hunting back and forth, it's right there. Big readable page numbers and model numbers make for quick finding of what you want.

**SPECIAL REFERENCE CHARTS:** Special late edition charts on tube and battery interchangeability, pilot lights, ohms law, color codes. The information you often search for is here. Also a special article by F. L. Sprayberry to make your wartime service job easier.

**COMPLETE DATA:** The big pages feature not only Schematics, but quick reference IF spot, Parts Lists, Dial Stringing diagrams, tuning range and data, tube locations, voltage charts, trimmer locations, push button set-ups, alignment notes and procedures, record changer details.

Published By  
**RADCRAFT PUBLICATIONS, INC.**  
25 WEST BROADWAY,  
NEW YORK 7, N. Y.

RADCRAFT PUBLICATIONS, INC., 25 WEST BROADWAY, NEW YORK 7, N. Y. DEPT. RC 7-43  
Gentlemen: Enclosed find my remittance of \$10.00 for which send me, POSTPAID, my copy of the RADIO CIRCUIT MANUAL—1942

Name ..... Address ..... City ..... State .....

(Send remittance in form of check or money order; register your letter if you send cash)

# THE QUESTION BOX

## QUERIES

All queries should be accompanied by a fee of 25c to cover research involved. If a schematic or diagram is wanted please send 50c, to cover circuits up to 5 tubes; for 5 to 8 tube circuits, 75c; over 8 tubes, \$1.00.

Be sure to send the fullest possible details when asking questions. Give names and MODEL NUMBERS when referring to receivers. Include schematics of your apparatus whenever you have such. Serial numbers of radios are useless as a means of identification.

All letters must be signed and carry FULL ADDRESS. Queries will be answered by mail, and those of general interest reprinted here. Do not use postcards—postmarks often make them illegible.

No picture diagrams can be supplied.

Back Issues 1942, 25c each; 1941, 30c each; 1940, 35c each.

Any issue, prior to 1940, if in stock, 50c per copy.

### DIATHERMY APPLICATORS

**?** You published a circuit of a short wave diathermy machine in the May issue, but failed to add a few words of necessary explanation. How is the output applied to the patient? Are plates used for this purpose?—G. P. R., Veregin, Sask.

**A.** Plates are generally used for this purpose, though the Inductotherm (see Page 460 of the same issue) uses a coil.

The plates have an effect on the output tuning, their capacity varying according to their size and the thickness of the padding between them and the surface to which they are applied, it is necessary to obtain plates for the approximate frequency to which the machine is tuned. The one shown in the May issue was constructed to operate on a wavelength in the neighborhood of 16 meters.

These plates may be obtained from any medical supply house which deals in diathermy apparatus and supplies.

### WANTS GOOD AMPLIFIER

**?** Can you send me the issue of July, 1939, in which was printed a diagram and construction information on building a 10-watt, direct-coupled audio amplifier?—A. K., Chicago, Ill.

**A.** The issue of July, 1939, is exhausted. The diagram you require is printed on this page. Since all values and voltages are given, it should be possible to construct the amplifier direct from the diagram.

You will note that no output transformer is shown, the 3 output terminals being intended to attach to any transformer designed to work from a pair of 6L6's in push-pull.

### LOW-POWER AMPLIFIER

**?** Will you please send us a hookup for a small amplifier of three or four tubes. We have on hand . . . several 6Q7's, a 6V6 and a 5Y3. Not too much power is needed, but a good deal of gain and good quality is wanted.

**A.** The hookup shown is the one best fitted to the tubes you have on hand. It uses two 6Q7's as straight triodes, followed by a 6V6. Some experimenting will have to be done with the fixed tone control in the output circuit, as it should be varied to meet your tastes and the characteristics of the

apparatus with which it has to work.

The diode plates of the 6Q7's can be left floating, or better, tied to the cathodes. The variable tone control, or treble cut-off circuit, is in the grid circuit of the 6V6, therefore using higher impedances than similar networks in the plate circuit.

Quality will be helped by the use of a large, low resistance choke. The 100,000-ohm resistor in the first plate lead may also be replaced by a small choke, with some increase in gain.

All values are in ohms or microfarads except where otherwise stated.

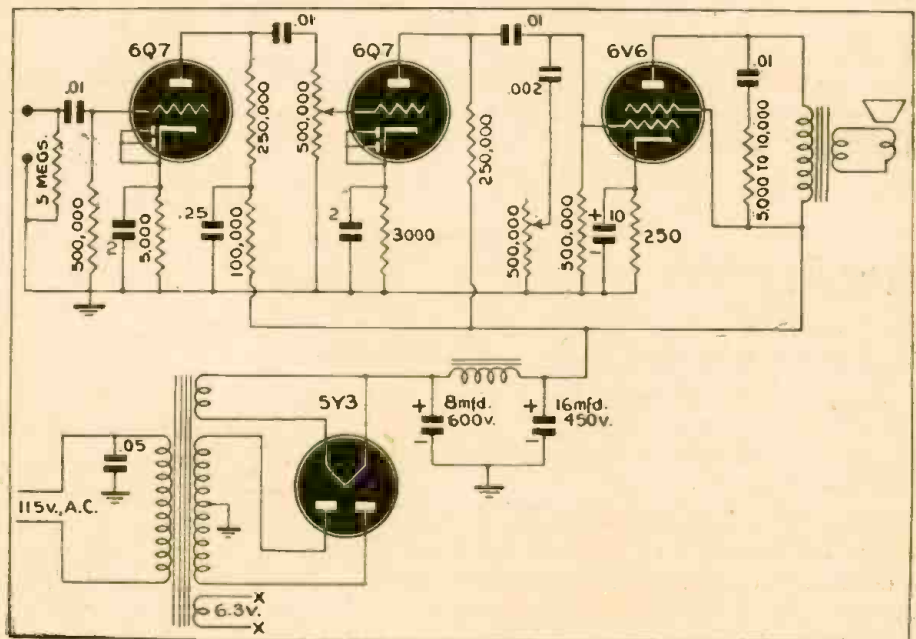

Complete schematic diagram of the high-fidelity, 5-tube, 10-watt, all push-pull direct coupled amplifier.

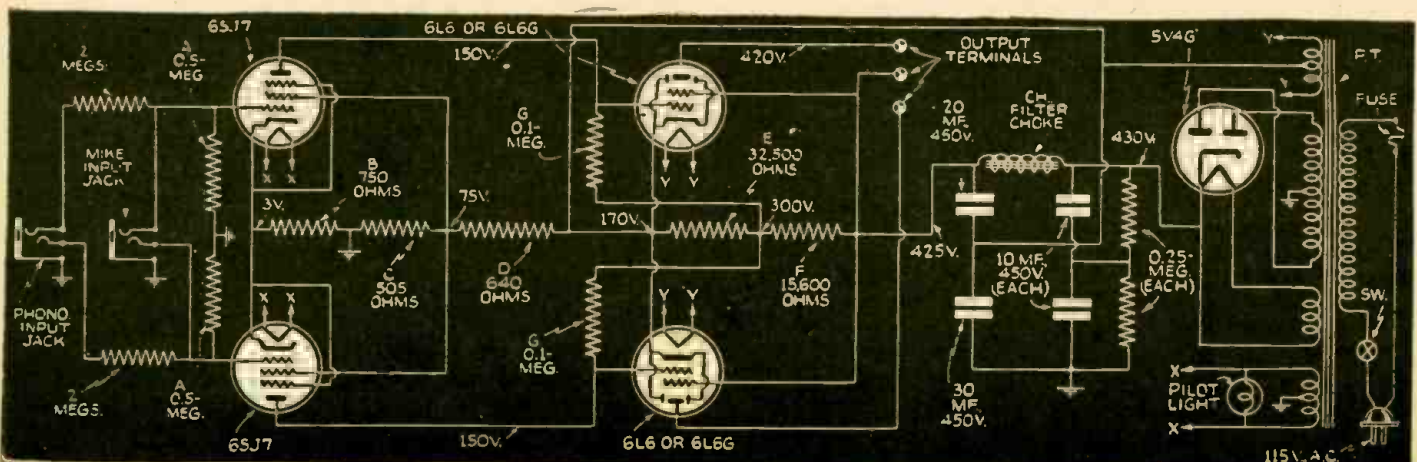

# TO HIT 'EM H-A-R-D-E-R



**T**HE year 1943 promises to be the grimmest, hardest year this country has ever faced. Every effort, and every dollar of national income not absolutely needed for existence, should go into war work and War Bonds.

In the Pay Roll Savings Plan, America finds a potent weapon for the winning of the war—and one of the soundest guarantees of the preservation of the American way of life!

Today about 30,000,000 wage earners, in 175,000 plants, are buying War Bonds at the rate of nearly half a billion dollars a month. *Great as this sum is, it is not enough!* For the more dollars made available now, the fewer the lives laid down on the bloody roads to Berlin and Tokio!

You've undoubtedly got a Pay Roll Savings Plan in your own plant. But how long is it since you last checked up on its progress? *If it now shows only about 10% of the gross payroll going into War Bonds, it needs jacking up!*

This is a *continuing* effort—and it needs *continual* at-

ention and *continual* stimulation to get fullest results.

You can well afford to give this matter your close personal attention! The actual case histories of thousands of plants prove that the successful working out of a Pay Roll Savings Plan gives labor and management a common interest that almost inevitably results in better mutual understanding and better labor relations.

Minor misunderstandings and wage disputes become fewer. Production usually increases, and company spirit soars. And it goes without saying that workers with substantial savings are usually far more satisfied and more dependable.

And one thing more, these War Bonds are not only going to help win the war, they are also going to do much to close the dangerous inflationary gap, and help prevent post-war depression. The time and effort *you* now put in in selling War Bonds and teaching your workers to save, rather than to spend, will be richly repaid many times over—now and when the war is won.

You've done your bit  Now do your best!

# • LATEST RADIO APPARATUS •

"KNOW-HOW"  
IN A PACKAGE

## SYLVANIA SERVICEMAN SERVICE

by  
**FRANK FAX**



**JUST 70¢ BUYS:**



**No. 1**  
Technical Manual  
**35¢**

**No. 2** →  
Tube Complement Book  
**35¢**

**No. 3** →  
Characteristics Sheet  
**FREE**

**No. 4** →  
Correlation of Tube Types for Substitution Chart  
**FREE**

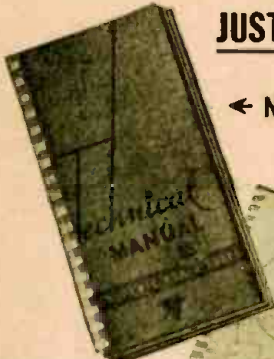
**No. 5** →  
Sylvania Base Chart  
**FREE**

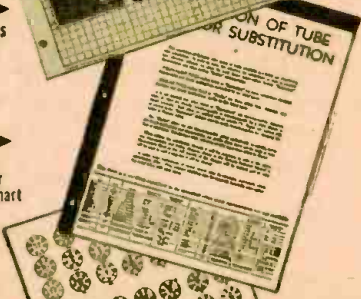
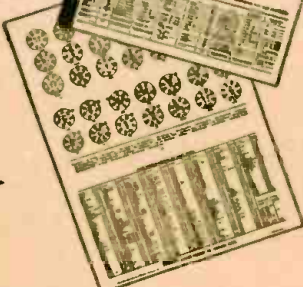
• If your jobber cannot supply you, mail your order to Frank Fax, Dept. RC-7 Sylvania Electric Products Inc., Emporium, Pa.

# SYLVANIA

**ELECTRIC PRODUCTS INC.**  
RADIO DIVISION

## ELECTRONIC TIME METER MEASURES MICROSECONDS

General Electric Co.  
Schenectady, N. Y.

A new electronic time-interval meter accurately measuring extremely short intervals—as low as 100 microseconds—has been announced by the Special Products section of the General Electric Company. Specifically, the meter is designed for measuring the time interval between two events which can be converted into electrical impulses, such as the elapsed time between the closing of two controls; between two impulses to a phototube; and between an electrical impulse and a light impulse.

Consisting of two units—an electronic panel and a phototube with its preamplifier stage—the meter has eight ranges, selected by means of a tap switch so that any time interval of a length between .0001 second and 3 seconds can be measured. A standard indicating instrument calibrated in milliseconds gives a direct reading of the time interval measured.

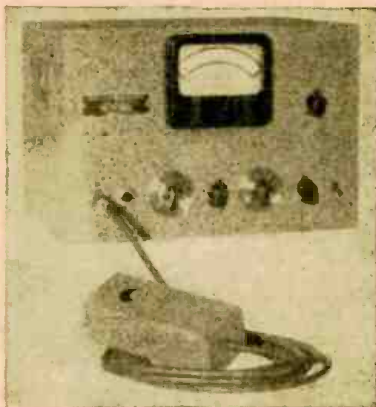

The normal input signals consist of changes of light intensity falling on the phototube or the making of external electrical contacts. In the former case, light values as low as 1/100 lumen, or an intensity of approximately 1.4 foot-candles, can be used on the photo-tube and still result in satisfactory performance.

Operating from a 115-volt, 60-cycle lighting circuit, the meter is stabilized so that normal line-voltage variations do not affect its accuracy, which is two per cent of full scale value, or one scale division. The meter will continue to indicate the time interval after measuring, with a drift of less than one division per minute. When another reading is required, a push button immediately clears the dial.—Radio-Craft

## STABLE HALF-WAVE RECTIFIER

Selenium Corp. of America  
Los Angeles, Calif.

PERMANENTLY stable characteristics are claimed for this new rectifier, known as the Type N. A special forming process has given it an unlimited life. Working temperature range extends from 70° C to +75° C. and a negative temperature coefficient is exhibited. All associated equipment, such as meters, relays, etc. have positive temperature coefficients with resulting compensation when used with selenium rectifiers.



The N-2 consists of two rectifying elements of 5/32 in. diameter as assembled in a tubular plastic case 15/64 in. and is rated 10 Volts A.C. The 20 Volt A.C. unit will, therefore, consist of four rectifying elements and a rectifier rated 40 volts A.C. will consist of a rectifier stack of 8 elements. D.C. current rating for continuous load is 1 Ma; for instantaneous load, 3 Ma.

Impedance in the forward direction is in the order of 1000 ohms. Impedance in the reverse direction is in the order of 1 Meg-ohm per plate.

All units are hermetically sealed with special sealing compound so that the assembly is independent of atmospheric changes and impervious to moisture. Two soldering terminals are provided.—Radio-Craft

## AUTOMATIC VOLTAGE TESTER

Superior Instruments Co.,  
New York City

THE model 590 voltage tester is a useful continuity tester and indicates roughly the voltage across it, as well as whether A.C. or D.C. and the polarity of current if D.C.

Four neon lamps are used as voltage indicators. These light respectively on 110, 220, 440 and 660 volts. No switches or jacks are used—the same connections are used on all tests and voltages. Inspection of the lamps indicates type of current, polarity, and even makes it possible to distinguish 25-cycle from 60-cycle current.

The unit is put up in a hand-size case 1 3/4 x 1 5/8 x 5 inches, with a pair of test leads and prods. Less than a milliampere of current is drawn, and the device is extremely rugged, being described as a "bang-around" instrument.—Radio-Craft



## HIGH-ACCURACY RESISTORS

Instrument Resistors Co.,  
Little Falls, N. J.

THESE slotted-terminals, high-accuracy INRES-CO resistors were expressly de-

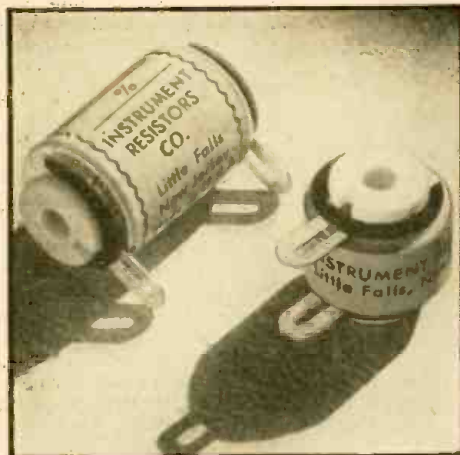

signed to meet the complex and intricate integrating requirements of precision apparatus and equipment.

Where available area is at a minimum, and the weight factor vitally important, Type P-2 and P-4 wire wound resistors have the added advantages of being minute in size and inconsequential in weight.

Type P-2 has one-half watt rating with a maximum resistance of 500,000 ohms. It measures only 9/16" long with a diameter of 9/16". Type P-4, with a one watt rating, has a maximum resistance of one megohm. Measurements are 1" long and 9/16" in diameter.

Terminals on both types are .025 hot tinned copper, slotted to take stranded or solid wire. Mounting is permitted by No. 6 holes through centers of bobbins.—Radio-Craft

### ELECTRONIC LEVEL CONTROL

Photoswitch Incorporated  
Cambridge, Mass.

**T**HIS new series of electronic level controls is designed particularly for hazardous location mounting. The equipment is especially adapted to use with conductive liquids of an explosive nature.

Two types are available, for high-level and low-level control respectively. Each is

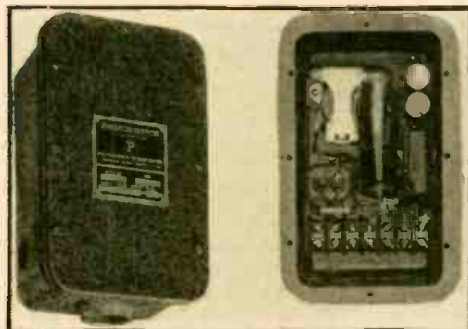

furnished as a complete unit in a vapor-proof cast-iron housing for direct tank installation. A one-inch nipple screws into the hub at the bottom of the control housing, and is screwed into a one-inch flange on top of the tank. From the control, a probe rod projects through the nipple and into the tank to the desired depth. The probe is supplied as standard in one-half inch diameter brass. Other metals are available if required.

High-level control is accomplished when liquid rises and contacts the probe tip; low-level control, when liquid drops below the probe tip. Both models incorporate a safety feature providing for operation of the relay in case of current or tube failure.

Of particular interest is the use of the equipment to control the level of any conductive liquid, such as water or acids in

tanks of gasoline. In this application the control remains inoperative while the probe is immersed in the non-conductor, but when the conductive liquid rises to the probe tip, the relay operates. This application is especially pertinent to the petroleum and chemical industries, where it is frequently necessary to provide a safeguard against too much condensation accumulating at the bottom of a tank, or to indicate when a conductive liquid rises to a definite point.—Radio-Craft

### CONDENSER ALTERNATES

Aerovox Corporation  
New Bedford, Mass.

**A** new line of compact tubular oil-filled condensers has been developed to take the place of unavailable mica units. These "mica alternates" are listed as type 38.

They are metal-cased and take up little more room than the mica capacitors they are intended to replace.

Units are available with terminals insulated or with one grounded.—Radio-Craft

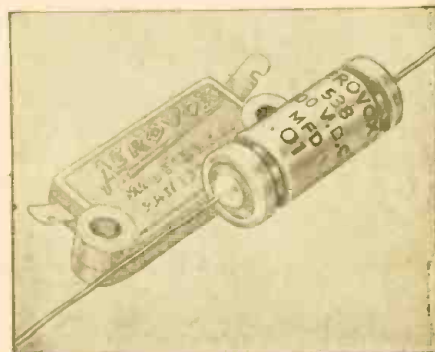

**EXCELLENCE  
IN MUSIC AND VOICE  
RECREATING INSTRUMENTS**

**AUDIOGRAPH**  
THE FIRST NAME IN SOUND

After Victory you'll find great changes. Among them: Great improvements and great simplifications in Sound and its Projection and a much wider application of its principles in business and at home. Economies in manufacture will follow simplification with consequent savings to the consumer. But that will be only one of the many distinguished values you will enjoy in Audiograph — a product of our Family of Activities in the field of electronics.

**JOHN MECK INDUSTRIES**  
PLYMOUTH, INDIANA



**I'LL SHOW YOU HOW TO GO PLACES IN RADIO MILITARY OR CIVILIAN**



**TRAIN IN SPARE TIME AT HOME . . . . or AT CAMP**

The greatest OPPORTUNITY that ever existed in Radio is open to you RIGHT NOW! Don't miss it! My practical Home Training will fit you quickly for a profitable Radio Repair business of your own . . . OR for a good-paying job in one of the Nation's Radio plants at work on equipment for planes, tanks, ships, etc. . . . OR for higher rating and better pay if you enter the Army, Navy or Marines.

**NO PREVIOUS EXPERIENCE NEEDED**

Sprayberry Training starts right at the beginning of Radio. You can't get lost. My tested and proved methods will get each subject across to you in simple, understandable style. Your success is my full responsibility. You learn Aviation Radio, Radio Set Repair and Installation Work, Mobile Radio (Auto-Tank), Television, Frequency Modulation, Signal Training, etc. You will be prepared to cash in on the coming great era of Electronics and Electronic equipment.



**READ WHAT THIS GRADUATE SAYS "Salary Has Increased"**

"Since I have finished your Radio training I had to enlarge my laboratory with additional equipment, as I have all the Radio repair work that I can handle. My salary has increased to 50 to 75 dollars a week. I install transmitter equipment and public addressing systems. Money can not buy the training that I received through your Academy." Asa Smith, Post Box 528, Ft. Leavenworth, Kansas.

**EARN WHILE YOU LEARN**

Along with your Training, you will receive my famous Business Builders which can bring you in a nice profit shortly after you begin my Course. No matter if you remain a civilian or enter military service, my Radio Training will give you the background and knowledge to cash in on the marvelous future that lies ahead.

**EASY TO START . . . .**

Remember it is not necessary for a Sprayberry student to have any previous experience in the field of Radio. You can master the Course in your spare time. It will not interfere in any way with your present duties.

GET THE FACTS ABOUT MY TRAINING—NOW! TAKE THE FIRST IMPORTANT STEP TOWARD THE MONEY-MAKING FUTURE OF YOUR DREAMS. ALL FEATURES ARE FULLY EXPLAINED IN MY BIG, ILLUSTRATED FREE BOOK. WRITE FOR IT AT ONCE.



**RUSH THIS COUPON FREE for BIG FREE BOOK**

**DON'T DELAY! ACT NOW!**

SPRAYBERRY ACADEMY OF RADIO  
F. L. SPRAYBERRY, Pres.  
620-G University Place, N. W., Washington, D. C.  
Please send me FREE copy of "HOW TO MAKE MONEY IN RADIO."

Name . . . . . Age . . . . .

Address . . . . .

City . . . . . State . . . . .

Tear off this coupon, mail in envelope or paste on penny postcard.

**THE LISTENING POST**

(Continued from page 614)

Mc.	Call	Location and Schedule	Mc.	Call	Location and Schedule
9.755	—	DURBAN, SOUTH AFRICA. Day and night transmissions.	7.22	VLI-4	SYDNEY, AUSTRALIA.
9.720	XGOA	CHUNGKING, CHINA. 7 am to 1 pm.	7.171	XGOY	CHUNGKING, CHINA. East Asia beam, 2:30-4 pm; 7:35 to 9:55 am; European beam, 4 to 5 pm; 11:35 am to 12:30 pm; Asia-Australia-New Zealand beam, 6 to 6:30 am; East Russia beam, 6:30 to 7 am; Japan beam, 7 to 7:30 am; North American beam, 10 to 11:30 am.
9.700	WRUW	BOSTON, MASSACHUSETTS. 5:15; 7:30 pm; 7:30 pm to 2 am.	7.15	GRT	LONDON, ENGLAND. 10:45 pm to midnight.
9.69	GRX	LONDON, ENGLAND. 10:45 pm to 12:45 am.	6.160	CBRX	VANCOUVER, CANADA. 10:30 am to 2:30 am.
9.690	BBC	LONDON. 10:45 pm to 12:15 am.	6.150	CJRO	WINNEPEG, CANADA. Sunday, 10 am to 12 midnight; daily, 7:30 to 1 am; Saturday, 7:30 am to 2 am.
9.690	LRAI	BUENOS AIRES. Afternoons.	6.148	ZRD	DURBAN, SOUTH AFRICA. Day and night transmissions.
9.685	TGWA	GUATEMALA CITY, GUATEMALA. Night transmissions.	6.145	HJDE	MEDELLIN, COLOMBIA.
9.680	VLW6	PERTH, AUSTRALIA. 9 am.	6.130	CHNX	HALIFAX, NOVA SCOTIA. Sundays, 8 am to 6:55 pm; Monday to Thursday, 6:45 am to 10:15 pm; Friday, 6:45 am to 11 am; Saturday, 6:45 am to 11 am.
9.670	WNBI	BOUND BROOK, NEW JERSEY. European beam, 2 to 4 am, 5:15 to 7:30 pm. Central American beam; 7:30 pm to 8 am.	6.120	—	BERLIN. North American beam, variable times.
9.650	WGEO	SCHENECTADY, N. Y. Australian beam, 7:15 to 8 am.	6.11	GSL	LONDON, ENGLAND. American beam, 7 pm to 12:45 am.
9.650	WCBX	BRENTWOOD, NEW YORK. Latin American beam, 1 to 11:30 pm.	6.098	ZRK	CAPTOWN, SOUTH AFRICA. Day and night transmissions.
9.640	COX	HAVANA, CUBA. 1 to 11:15 pm.	6.095	OAX4H	LIMA, PERU. "Radio Mundial."
9.635	XGOY	CHUNGKING, CHINA. East Asia beam, 2:20 to 4 pm; European beam, 4 to 5 pm; East Asia beam, 7:35 to 9:55 am; North America beam, 10 to 11:30 am; European beam, 11:35 am to 12:30 pm.	6.090	CBFW	VERCHERES, CANADA. Daily, 7:30 am to 11:30 pm in French.
9.63	—	ROME, ITALY. 10:30 pm.	6.082	OAX4Z	LIMA, PERU. "Radio Nacional."
9.626	ZRL	CAPE TOWN, SOUTH AFRICA. Daylight transmissions.	6.080	WLWO	CINCINNATI, OHIO. European beam, 12:15 to 6 am.
9.615	VLI	SYDNEY, AUSTRALIA. North American beam.	6.070	CFRX	TORONTO, CANADA. Sundays, 9 am to 12 midnight; Monday to Friday, 7:30 am to 12:05 am; Saturday, 7:30 am to 12:45 am.
9.595	—	ATHLONE, IRELAND. "Radio Eireann." 7:10 to 8 pm.	6.060	WCDA	BRENTWOOD, NEW YORK. Central American beam, 7:15 pm to 2 am.
9.59	WLWO	CINCINNATI, OHIO. East South American beam, 7 to 12 pm.	6.040	WRUW	BOSTON, MASSACHUSETTS. European beam, 6 to 7 am.
9.580	GSC	LONDON. North American beam, 5:15 pm to 12:45 am.	6.030	CFVP	CALGARY, CANADA. Sunday, 10 am to 1:30 am; Monday to Saturday, 8:30 am to 2 am.
9.565	JRAK	TOKYO, JAPAN. 7 to 9:30 pm.	6.010	CJCX	SYDNEY, NOVA SCOTIA. Monday to Friday, 7 am to 11 am; Saturday, 6:45 am to 11 am; Sunday, 8 am to 11 am.
9.562	OAX4T	LIMA, PERU. "Radio Nacional" 2 to 8 pm, daily.	6.007	ZRH	JOHANNESBURG, SOUTH AFRICA. Evening transmissions.
9.543	XEFT	MEXICO. Evenings.	6.005	CFCX	MONTREAL, CANADA. Sunday, 7:30 am to 12 midnight; Monday to Saturday, 6:45 am to 12 midnight.
9.535	JZI	TOKYO, JAPAN. 8 to 9 am; 2:15 pm; 7 to 9:30 pm.	5.85	—	SANTIAGO, CHILE. 7:40 pm to midnight.
9.535	SBU	MOTALA, SWEDEN. 12 to 2:15 pm.	4.925	HJAP	CARTAGENA, COLOMBIA.
9.523	ZRH	JOHANNESBURG, SOUTH AFRICA. Daylight transmissions.	4.905	HJAG	BARRANQUILLA, COLOMBIA.
9.520	DXL13	BERLIN. North American beam, 5:50 pm.	4.885	HJDP	MEDELLIN, COLOMBIA.
9.505	JLG2	TOKYO, JAPAN. 2:15 pm.	4.865	HJFK	PEREIRA, COLOMBIA.
9.480	—	USSR. Heard at 8 pm.	4.835	HJAD	CARTAGENA, COLOMBIA.
9.480	AFHQ	ALGIERS. 6:30 to 7:45 pm.	4.785	HJAB	BARRANQUILLA, COLOMBIA.
8.860	—	West South American beam, 8 to 12 pm.			
8.660	—	West South American beam, 8 pm to 2 am.			
8.484	XPSA	KWEIYANG, CHINA. 7:30 am to 12 noon.			
8.035	CNR	RABAT, MOROCCO.			
7.565	WDJ	North Africa beam, 11:45 pm to 2 am.			
7.495	—	CAIRO, EGYPT. 3:15 to 6 pm.			
7.35	WBS	Opens at 1 pm.			
7.290	DJX	BERLIN. Variable times, North American beam; news in English at 7 pm and other times.			

## NEW ELECTRONIC ROASTER CALLS "TURN" ON COFFEE

(Continued from page 586)

chamber, contains the reflector, the starter lamp, lens and mountings for same. At the lower end of the chamber is situated an exit, covered by a hinged gate, which usually is kept closed by a spring-hinge. This gate is also provided with a depending arm which, when tilted in a discharge position, opens the gate by contacting a pin on the coffee receiving hopper. Thus, when the manually-operated handle is pulled to the right, the roasted coffee is dumped into the hopper.

### THE ELECTRON-TUBE RELAY

The wiring diagram of the electronic part of the coffee roaster is shown in Figure 2. It employs two commercial radio tubes, 6R7-G and 25L6, with the type R919 phototube. The latter is extremely sensitive, of the vacuum-type construction as a means of insuring extreme resistance against leakage between the electrodes. The output tube feeds into a relay that will function when 25 mil. of current flows through it. The resistance unit R1 is a sensitivity control. The unit operates from 110-volts, either alternating or direct current.

The triode section of the tube 6R7G, or duodiode medium mu triode, begins to oscillate, with the inductance L1 and capacity C1 as the tank circuit, and as outlined in the circuit-diagram values outlined in a succeeding paragraph. These oscillations, however, stop shortly because the grid builds up a negative charge on the condenser C2 and thus blocks the tube. Oscillation begins again when the grid derives a sufficient positive charge, through the phototube R919, to unblock it. The same cycle, oscillation superseded by cut-off, is repeated.

While oscillations continue, the cathode of the 6R7-G is alternately positive and negative with respect to the diode plates of the tube. During each alternation when the diode plates are positive, current is drawn. This keeps the grid of the 25L6 sufficiently negative to keep the relay open. When cut-off of the 6R7-G occurs—or at a point before cut-off, selected by varying the resistor R1—the 25L6 grid bias may decrease to a point where the plate current will be sufficient to operate the relay.

The duration of the cut-off period depends upon the rate of flow of charge through the photo-tube R919 which, in turn, depends upon the illumination of the latter. Thus, this circuit may be adjusted to operate a relay when a specified degree of light falls on the photoelectric cell—and this light may be the product of the changing color of coffee from green to brown during the roasting process.

Circuit values for Figure 2 are as follows:

- C1.—20 to 150 micromicrofarads.
- C2.—50 micromicrofarads.
- C3.—5 microfarads.
- C4.—4 microfarads.
- L1.—1 to 10 millihenrys, center tapped.
- R.—0-25 milliamperes relay.
- R1.—100,000 ohm variable resistance.
- R2.—5 megohm resistance.
- R3.—50 ohms, 1 watt.
- R4.—280 ohms, 25 watts.

The diagram of Figure 2 is connected at R to point R' in Figure 3 and also the 110-volt circuit at AB, Figure 2 connects with points a, i, Figure 3. Let's assume that a batch of coffee is in the electronic roaster ready for roasting—that the manual reset MR, Figure 3, has been set to close the circuit to the starter light and heater—now close the switch B, which sets the roaster

in motion. Thus the beans begin browning and continue to do so until the desired degree of color is attained. Then the amount of light reflected in the phototube R919 is reduced, thus cutting down the flow of current in the electronic circuit. This, in turn, activates the relay, as described, permitting the closing of the contact points j, energizing the second relay k, raising bar m, which opens contacts r and e. This shuts off the starter light and heater; at the same time contacts p and q close, ringing a bell to

warn that the coffee is roasted. The buzzing of this signal is discontinued by the operator opening the switch n. (Manifestly, the quantity of light rays reflected to the phototube R919, are determined by the color of the coffee.) Switch b is manually operated and the complete circuit opened.

This roaster is so complete in every detail that automatic agitators are located in the device for stirring the beans during the roasting process, and the smoke and gases are discharged through an exhaust pipe.

## Replace with Meissner Universal Adjustable Coils

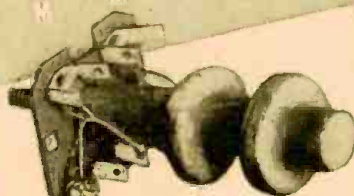

Adjustable  
H. F. Coil



Adjustable  
Oscillator Coil



Adjustable  
Antenna Coil

Meissner Adjustable Inductance Ferrocart (iron core) coils are designed to replace the Broadcast band coils in practically any receiver. When an antenna, R.F. or Oscillator coil requires replacement use a Meissner Universal Adjustable Coil.

Universal Adjustable Coils are continuously variable in inductance over a wide range, the coils will accurately "track" with the other coils in the receiver when properly adjusted. The exact inductance of the old coil is easily matched by a very simple adjustment regardless of the value of the tuning condenser.

Universal Adjustable Coils are available at your  
MEISSNER distributor.

**Meissner**  
MT. CARMEL, ILLINOIS  
"PRECISION-BUILT ELECTRONIC PRODUCTS"

**ALLIED...**

**ARSENAL of SUPPLY for EVERYTHING in RADIO and ELECTRONICS.**

EVERYTHING IN RADIO AND ELECTRONICS  
1943  
ALLIED RADIO  
833 WEST JACKSON BLVD. CHICAGO, ILLINOIS

**GET** all your Radio and Electronic needs quickly from this ONE dependable central source of supply...over 10,000 items for the Armed Forces, for Radio Training, for Research Laboratories, for War Industries, and for Service Replacement. Our large complete stocks speed delivery. Our experienced staff is ready to help you.

**USE THE NEW ALLIED CATALOG!**  
Most Complete Up-to-date Buying Guide  
**Free**

**6 Radio Books for 75c**

Dictionary of Radio Terms. No. 37-751 <b>10c</b>	Radio Data Handbook. No. 37-754 <b>25c</b>
Radio Circuit Handbook. No. 37-753 <b>10c</b>	Radio Builders Handbook. No. 37-750 <b>10c</b>
Radio Formulas & Data Book. No. 37-752 <b>10c</b>	Simplified Radio Servicing. No. 37-755 <b>10c</b>

*Write for Quantity Prices*

ALLIED RADIO CORP., Dept. 2-G-3  
833 W. Jackson Blvd., Chicago, Ill.

Please send following books (.....c enclosed)  
 FREE  37-750  37-752  37-754  
 1943 Catalog  37-751  37-753  37-755  
 Send All 6 Books

Name.....  
 Address.....  
 City..... State.....

**ALLIED RADIO**

**"HEATRONIC" MOLDING FOR BETTER PLASTICS**

(Continued from page 589)

is a perfect job, while that at the left failed to "fill" due to insufficient plasticity for the pressure used. Not only is there a direct advantage, in that lower pressures may be used or harder flow materials molded at the same pressures, but indirect advantages are also obtained. Thus larger molds may be used in available presses, and wear on molds is reduced, with a corresponding decrease in costs.

Heatronic molding opens up a whole new field in the production of objects formerly considered too big to mold. This covers not only those of thick cross section, but also of large area. Such items could in some cases be molded with non-electronic methods, but the cost would make such work economically impractical. The new method will mold not only bigger jobs and thicker ones, but will turn out better quality work at a rate which cuts costs to a commercial level. Examples of thick pieces moulded by the Heatronic method (right) and standard molded (left) are seen in Fig. 3.

**THE SOURCE OF R.F. POWER**

A typical electronic heating unit used in plastic molding appears in Fig. 4. Power supply and oscillator are both contained in this rack, which is no larger than that of a medium-sized amateur transmitter. Self-excited push-pull circuits are the favorites. Almost any one of the standard circuits could be used, as the only factor of importance to consider is that of R.F. power output. It is possible that later designs may see refinements in heater oscillators, made with the idea of increasing the input-output efficien-

cy. At present other problems are of greater importance.

Care in the design of the electrodes is necessary, however. It is essential that they be as large as or larger than the object placed between them to heat. Efficiency demands that they be of the same general shape as the object, and make uniform contact with it. This condition is easy to meet in the field of molded plastics. Air gaps between the plate and the material being heated could introduce power losses and call for such increased voltages as to make the system electrically and economically impractical.

Excellent and "low-loss" insulation for the "hot" condenser plate must be provided. The other one may be at ground potential. The whole electrode assembly should be completely surrounded by a grounded shield. This protects workmen or others who may be near by, and prevents radio interference.

It is generally believed that we are about to enter—if indeed we are not already entering—an Age of Plastics. In such case, application of electronic methods of molding to the greater number of plastic products will result in a welcome extension of the electronic industry. Although electronic heating apparatus is simple and straightforward, the oscillator units and their associated power supplies will require a certain amount of servicing, which will extend the employment field of electronic repair and maintenance men.

All photos furnished through courtesy of Bakelite Corp.

**POPULAR ELECTRONICS**

(Continued from page 585)

ever source of D.C. is used for the plate charge.

Any one of a number of circuits may be used for the production of sustained oscillations or alternating current. Some of these with their special names are shown in the drawings of Fig. 7. Of course, the frequency of the alternating current generated by such a circuit will depend upon the electrical characteristics of the circuit. Circuits heavily loaded with inductance (wire), capacitance (condensers) or resistance, will produce low-frequency current. Those with little of these factors will produce high-frequency currents.

much beyond the means of the amateur investigator. However, the ingenious worker may employ a neon sign transformer, an ignition transformer from an oil burner or a spark coil for the creation of this kind of heat. The simple circuit is shown in Fig. 8. While it will not be possible to generate heat rapidly with this crude equipment it can nevertheless be generated. Here the high-frequency currents produced by the discharge of the condenser are induced in the piece of iron where they are short-circuited.

So much for vacuum tubes. Again the student is asked to carry the study of these

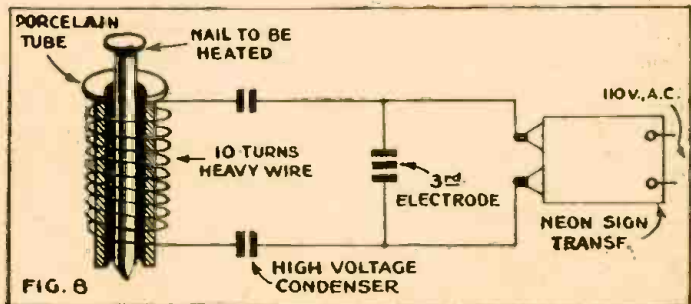

A simple "induction furnace" for demonstrating the heating effects of radio-frequency current. The experimenter may be interested in trying to cook a string bean or other object in this apparatus.

**EXPERIMENT IN R.F. HEATING**

The experimentally inclined reader will probably wish to conduct some experiments with radio inductive heat. Although the heavy power triode is now being used for this purpose, such facilities were pretty

tubes beyond the point necessarily limited by space in this presentation of the elements of electronics.

Our next installment will have to do with photoelectrics and the construction of home-made photoelectric cells.



## NEW DEATH-RAY PRESERVES LIFE

(Continued from page 587)

to kill—was the slipper-shaped paramecia. This innocent organism was selected to be the new martyr to science, and billions of them were cultured for experiments.

When exposed to the rays, blisters appeared on their surfaces. The organisms quickened their movements, swimming about the drop of water in which they were imprisoned as though attempting to escape. Shortly, the blisters increased in size, and the paramecia literally exploded.

The lamp is coming into ever wider use, not only in hospitals—where it is fast becoming a "must"—but for sterilizing the air in places where large numbers of people

congregate. Air-conditioning systems of the future will certainly include it, and this may spell the doom of that ancient enemy of mankind, the common cold.

In the field of refrigeration, it kills mold and bacteria, who are merely rendered immobile, not destroyed, by the cold. Temperature and humidity levels in treated refrigerators can be raised, with consequent economy and improved preservation of the product. Bakeries are among the first to avail themselves of the lamp, the first useful protection against the baker's bugbear, mold. Heat and humidity make bakeries a happy hunting-ground for this fungus, and

no previous method of sterilization could be applied to bread.

With the exception of the baby of the family, which starts on 160 volts and operates at 105, with a current not exceeding 0.05 ampere, these lamps are rated from 15 to 30 watts approximately. The starting voltage may be as high as 750, which is supplied by a transformer mounted on the lamp fixture. This transformer is designed to supply 1,000 volts on open circuit, and is so designed that the load of the lamps will bring it down to proper operating voltage, which ranges between 250 and 500 volts, being higher for the larger lamps.

### ELECTRIC MEMORY MACHINE HELPS IGNITRON STUDY

(Continued from page 588)

denser as it leaves O and assures that it has no charge as it again moves under the input brush.

The Memnoscope has been of great value in rectifier research, and may be applicable to other investigations. Before its invention, the prevailing opinion had been that arc-backs occurred only during transition time, just at the end of each conducting period, when the gas in the tube is in a highly ionized state. Oscillograms obtained with the Memnoscope show that arc-backs do occur at other times during the inverse cycle. Such oscillograms have given information which has led to improved designs and to very substantial increases in the ratings of Ignitrons.

### U. S. BUREAU OF MINES SEEKS QUARTZ CRYSTALS

The greatly increased need for quartz crystals—together with transportation difficulties in obtaining the valuable mineral from Brazil—has given rise to concentrated efforts to uncover new supplies in the United States, according to a statement of the Bureau of Mines last month.

The U. S. Bureau of Mines has assigned a geologist to cover the State of Arizona, and the Arizona Bureau at Tucson has installed equipment for testing crystals without charge.

The State Department of Mineral Resources is mapping all known sources of crystals to help speed the search, and the geologist in charge will carry extensive equipment for making field tests. One of these is an "inspectroscope" to test for crystal twinning.

The best quartz crystals are now worth more than \$30.00 per pound.

A SIX-RECORD album devoted to code instruction has been released by RCA-Victor. The records contain both code practice and verbal instructions. The more advanced records are composed largely of cipher groups, thus eliminating memorizing of the material, which is often a stumbling block in mechanical code-teaching methods.

The lessons were prepared by Mr. John N. Cose, Director of Instruction at RCA Institutes, New York City.

# Get into RADIO now!

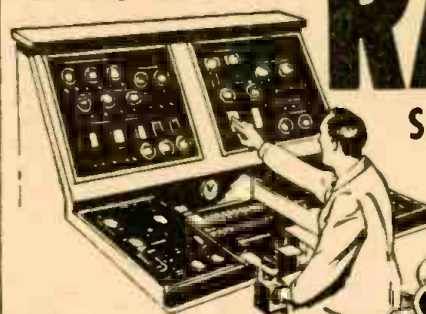

SHOP METHOD HOME TRAINING  
fully qualifies you for bigger pay jobs

## BIG OPPORTUNITY FOR NATIONAL GRADUATES

Shortages in trained, skilled men run into the hundreds of thousands. One of the biggest fields is RADIO, with its many fascinating branches. Wartime demands for Radio men are tremendous and will continue UNABATED after the war. That's important to you. You want training in a field that will continue to advance. National Schools offers you a time-tested method of Home Training which has helped thousands of men to more pay, and unlimited opportunity in the growing RADIO industry. You can actually start earning in Spare Time, even while you are training for a good permanent job as a RADIO technician. You need training. National can definitely help you. Simply send the Coupon and we will mail you a FREE Specimen Lesson and Big Opportunity Book so you can judge for yourself just how you can be helped to bigger pay and a Life Career of Success.

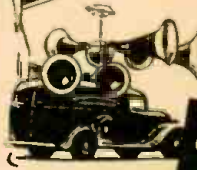

More than 50,000,000 radios in use. They need servicing. Over 800 Broadcasting Studios employ trained radio technicians. The movie industry and thousands of theatres employ Sound experts. Factories are adopting audible address system. The Air Lines and Government need Trained Men. Here is your opportunity to get into a permanent, profitable field of enjoyable work.

COMMAND ANY OF THESE JOBS  
Radio Expert  
Radio Broadcasting  
Sound  
Talking Pictures  
Studio Technician  
Television Technician

You profit by a fascinating career in

RADIO  
RADIONICS  
ELECTRONICS  
TELEVISION

YOU GET HOME TRAINING FROM A REAL, ESTABLISHED TECHNICAL TRADE SCHOOL



REGARDLESS OF YOUR AGE YOU CAN ENROLL

"I will train you in your spare time to qualify as a Radio Expert."  
J. A. Rosenkranz  
President

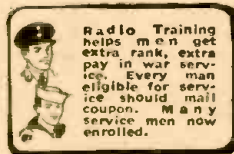

Radio Training helps men get extra rank, extra pay in war service. Every man eligible for service should mail coupon. Many service men now enrolled.

Duplicate the Success of These Graduates



O. K. IVEY H. SCHROEDER  
"National Schools has done wonderful work for the man who wants to get ahead in life. Your trained man can get a job at a much higher salary."  
O. K. Ivey,  
Washington, D. C.

"Your schooling helped me obtain a swell job. Now, in the Navy, I am following the profession I learned at National. It will help my chances for rapid advancement."  
H. Schroeder, U.S. Navy.

Thousands of Graduates Attribute Their Success to National Training



FREE LESSON & OPPORTUNITY BOOK

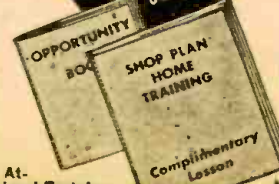

## NATIONAL SCHOOLS

Los Angeles California

ESTABLISHED 1905

MAIL OPPORTUNITY COUPON FOR QUICK ACTION

National Schools, Dept. RC-7 (Mail in envelope or 4000 So. Figueroa, Los Angeles, Calif. paste on penny postals)

Mail me FREE, without obligation, one lesson and Opportunity Book, with full details about how I CAN become a RADIO Technician.

NAME \_\_\_\_\_ AGE \_\_\_\_\_

ADDRESS \_\_\_\_\_

CITY \_\_\_\_\_ STATE \_\_\_\_\_

REQUEST FULL DETAILS

# HARRISON HAS IT!

**FOR URGENT  
WAR WORK—**

**HALLICRAFTERS**

**RECEIVERS AND  
TRANSMITTERS**

**TUBES**

**CONDENSERS  
RESISTORS**

**TRANSFORMERS**

**AND THOUSANDS OF OTHER  
CRITICAL ELECTRONIC PARTS!**

**PURCHASING AGENTS—**

Call upon us for your high priority requirements of equipment and components for your production and development work.

We usually have it in stock!

**FOR THE  
HOME FRONT—**

**CODE PRACTICE SET**

Buzzer and key, heavily nickel plated, of single unit construction, mounted on wood base. Adjustable high frequency pitch. Complete with silk covered cord, in attractive box with code chart on cover. Works on one or two flashlight or dry cells.

**Postpaid—\$2.45**

**6L6G** First grade, **\$1.37 ea.**  
meter tested, 3 for **\$3.75**  
**TUBES** fully guaranteed postpaid

**DYKANOL CAPACITORS**

Cornell-Dubiller oil filled, hermetically sealed metal cased condensers. 4 mfd. capacity. Rated at 250 Volts A.C. working, will stand over 600 Volts D.C. Ideal for amplifiers, receivers, power packs, etc. (Filtering action equivalent to 12 mfd. electrolytic but with better safety factor, longer life). \$2.25 (3 or more shipped postpaid).

**P. M. DYNAMIC SPEAKERS**

5 inch. with output transformer to match single plate of 8000 ohms **\$1.95**  
Magnavox, 10 inch. 16 ounce magnet! 6 ohm voice coil **\$5.25**  
(Not Postpaid)

Immediate delivery of the above items, without priority, while quantities last. **SEND REMITTANCE WITH ORDER, TODAY!** (Money back if not satisfied.)

# HARRISON

**RADIO CORPORATION**

11 WEST BROADWAY

Phone WOrth 2-6276

NEW YORK CITY 7

**GUARDING  
COMMUNICATIONS  
WHERE THE GOING  
IS TOUGH!**

**SUPREME**  
TESTING INSTRUMENTS

The famous 504-A and other SUPREME Testing Instruments are on active duty in all parts of the world. Now more ruggedly built, more accurate and dependable than ever, SUPREME Instruments will be your logical choice when victory is won.

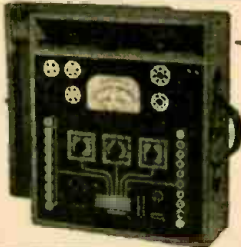

**SUPREME INSTRUMENTS CORP. GREENWOOD, MISSISSIPPI**

**WATCH PULSE  
MODULATION**

"Pulse modulation" is a big new radio idea which you will be hearing a lot about later. It grows out of war technique but seems to offer great new possibilities for peacetime civilian radio as well.

Military use is one of the reasons we hear no more about it now, but after the war—keep your eyes open!

## Complete Plans

For Building Useful and Practical Things at Home. Each issue of Popular Homecraft is crammed with plans for making such beautiful and useful things as: Furniture, Bird Houses, Lamps, Outdoor Garden Furniture, Candles, Equipment, etc. Covers all the work, tools, wood-working, leathercraft, copper, etc. You'll find "how" to make almost everything from the pages of Popular Homecraft. Scores of drawings and photographs make every step simple as A B C. A real "How-To-Do-It" magazine.



**Six Months' Trial \$1.00**

Send \$1.00 today for trial six months' subscription. Money Back If Not Delighted.

**POPULAR HOMECRAFT**

637 Palmolive Building

Chicago, Ill.

**Trial 6 Months \$1.00**

**MORE HIGHS—MORE LOWS**

(Continued from page 596)

if the circuit is not sufficiently damped. If this should occur, use a choke of poorer quality. Such a choke will have greater resistance and will be more highly damped. When using an audio transformer secondary, the writer made tests with an audio oscillator and an oscilloscope and found no ringing or hang-over effect whatever.

(This is the first of a series of two articles by Mr. Sands. Several ways of improving the bass response of an average radio are discussed. In the second part, further information on resonant bass re-inforcing circuits will be given, as well as a number of treble-boosting circuits.)

**KEEP 'EM PLAYING**

(Continued from page 593)

1E5GP, 1D5, etc., the 12SQ7 by the 12Q7, 7C6, etc., the 35L6 and 50L6 by the 35A5, 3Q5, 1G5, 1F4, 1F5, etc., the 35Z5 by the 35Z3, or 117Z6. Another alternate is to change over from 12 volt to the .300 ma series of octal or octal base tubes, using one of the many 25 or 32 volt, .300 ma output and rectifier tubes.

Where line resistance cords are difficult to obtain, a socket may be made available for a ballast resistor tube by replacing both the rectifier and output tubes with one dual purpose tube such as the 12A7, 32L7, 117L7, 117N7, etc. Good tubes salvaged and then resold as used tubes will be found to be very much in demand at all times. It will pay each serviceman rich dividends both in cash and in customer satisfaction to spend a bit of time after closing each day in figuring his present and probable shortages, then working out alternate circuits and tubes to offset them. In that way there will be no fumbling over manuals or books while the customer is in the shop; instead he will gain among his clientele a reputation as something of a local wizard. That reputation will not hurt his business now, and during the postwar era they will remember the place that gave quick service in spite of shortages.

**SHORTAGES IN OLD-TYPE TUBES**

Another group of tubes that seems to be a source of headaches in some areas, are the 80, 75, 6F6, 6H6, etc., as well as the 2.5 volt types. These tubes present a much simpler problem than the series types, as the filament current does not play such a predominant part in the change-over. The 80 may be replaced by any of the octal base 5 volt rectifiers, such as 5Y3, 5Y4, 5V4, 5W4 (where current drain permits) and by the 83V. Also, in cases where B current drain is not too heavy one may use the 84, 6X5, and 7Y4, all of which do a very good job on 5 volts. In changing to the octal types with 5 as the first figure of the type number, it is wise to connect the following tube prongs together at the base, making several types thus directly interchangeable. Connect 2 to 7, 3 to 4, and 5 to 6. This will save future changes, and it is also well to mark on the chassis the various types which are now interchangeable.

**WHY NOT USE A 6-VOLT TUBE?**

Where only one, or even two or three of the 2.5 volt types are out and not available, any similar 6.3 volt type may be used by connecting their filaments directly to the rectifier filament winding. It will handle several of the .150 ma or .300 ma types without damage to the power transformer. Reference to any tube chart or manual will divulge a myriad types with different type numbers but similar characteristics, which (due to large commercial tolerance in most radio circuits) are readily interchangeable with at most a mere wiring or a socket change indicated. All of this is very clearly shown in the tube manuals. For example, the 75 may be replaced by the 6Q7, 6T7, 6SQ7, 7B6, 7C6, etc., the 6A7 by the 6A8, 7A8, 7B8, etc., the 6SA7 by the 7Q7, etc. No attempt will be made to go through the entire tube category; the point is this: don't just hunt a number, hunt a type made for the same purpose. If you cannot get a 75, go through the list of duo-diode triodes until you find an available type. Make necessary wiring changes and then another family can keep up with current events. In

the foregoing listing of tube types, they can be metal, glass, GT, or GT/G, just so you bear in mind the fact that you are hunting a pentagrid converter, or triple grid amplifier; not merely a 6A8 or 6K7 tube.

**PUZZLES WITH OTHER PARTS**

Other radio component problems are easier to solve than tube changes, for the parts for substitution are usually on hand. Slip on primaries for most R.F. and I.F. coils are available, or the primary can be rewound from wire salvaged from old speaker field coils. It will be discovered that most of these primaries are not at all critical, and if shortage of wire or of time renders a rewind impractical, the plate may be resistance capacity coupled to the following secondary through a small mica condenser or a gimmick made of two pieces of insulated wire twisted together. Values of resistance and capacity are not critical, resistor from 10,000 to 50,000 ohms and capacitor from .0001 mfd to .00025 mfd work nicely. The input audio transformer in a push-pull circuit may be eliminated by wiring the 1st audio tube as a phase inverter. Resistance capacity couple plate to grid of one output tube. Then raise 1st audio cathode from 10,000 to 50,000 ohms above ground, bring 1st audio grid return to cathode, then connect cathode of 1st audio to grid of remaining output tube through a coupling condenser. Add .5 meg or 1 meg resistor from grid to ground to each output tube, and another radio is back among the living.

**SERVICING ELECTRONIC INSTRUMENTS**

I have used very similar methods in emergency servicing of Hammond Electric Organs, Solovox, Electric Guitars, etc., without any loss of tone or volume. The above instruments are a good source of income for any serviceman. Simply pay no attention to the trade name and apparent maze of wiring and the Organ will break down to a group of simple microphones feeding through a mixer transformer to a 2 tube preamplifier, with a 57 resistance coupled into a 56, which works into a plate to line transformer, which in turn drives one or more 20 watt amplifiers. Its common troubles are but the same as those commonly encountered in the audio sections of any radio. The solovox is nothing to be afraid of; simply a group of ordinary audio oscillators, interlocking with one another, feeding a standard amplifier.

**INDUSTRIAL CONTROL DEVICES**

The servicemen will also discover that most of the common electronic control devices are *much simpler* to service than the average radio; containing a photocell which with a given amount of light generates a bias control voltage which regulates the current in the plate circuit of the output tube, which is connected to a relay instead of an output transformer; yet many firms are finding it difficult to find servicemen in their area who will even attempt to service them. This field is one that it will pay every serviceman to investigate. There is a great demand for such service at present, and this demand will increase during the post war period. The medical profession is also in growing need of electronic and electrical service, due to shortage of trained factory technicians. Most such equipment consists basically of a not too complicated H.F. transmitter, or of nichrome ribbon heater elements in sterilizers which give open circuit troubles.

**R.F. SUPPLIES FOR SMALL LAMPS**

Some medical probing lights which are inserted into the body are being rendered useless by shortage of transformers and

HALLICRAFTERS ★ HALLICRAFTERS

**LET'S ALL PITCH IN!**

**WE CAN** all help win this war by selling our government the communications receivers and equipment they need quickly and in sufficient quantities.

That is the reason I pay *highest cash prices* for used communications equipment.

When this war is over you will be in the market for new equipment and by taking advantage of my offer to purchase your present equipment at highest cash prices you will be in a position to buy new and better equipment than you now own.

Write, telephone or telegraph me description of your used communications receivers, transmitters and parts of standard make; you will be paid cash immediately without bother or red tape. I am particularly interested in *Hallicrafters*.

*I also have a store at 2335 Westwood Blvd., West Los Angeles, Calif.*

**Bob Henry, W9ARA**  
**HENRY RADIO SHOP**  
BUTLER, MISSOURI



**COMPLETE STOCKS**

I still have large stocks of receivers, 2 1/2 meter equipment, meters, tubes, transformers, resistors, condensers, panels, chassis, and radio parts of all sorts. I sell and rent code teaching equipment. Your orders and inquiries invited.

"WORLD'S LARGEST DISTRIBUTOR OF COMMUNICATIONS RECEIVERS"



batteries; yet *any serviceman can make a very efficient light source* for them with a 117L7 hooked up with the pentode section in a Hartley oscillator circuit, and a few turns on the plate end of the oscillator coil, coupled to the light, does a better job than the original transformer. Even a 71A, with a 25 watt light bulb in series with the filament, will do the same job. This H.F. light circuit has proved to be particularly advantageous when used with a Cystoscope in bladder examination, for by tuning the coil on and off resonance the brilliance of the light may be controlled to any desired degree.

A bit of looking around will unearth many types of electronic equipment that is in need of servicing in order to keep our war effort on the home front in good working order, and all these devices are closely related to radio, based on the same fundamental circuits, using similar parts, and may be checked and serviced with the same equipment found in any up to date shop. All these devices must be kept in operation, as well as at least one radio in every home, before we who call ourselves servicemen can look a front line soldier in the eye and say we did our part in this war.

I know that all the methods outlined briefly in the foregoing paragraphs will work, for I have used them all and many more in my own shop; and we are about as short of all parts and tubes here in Louisiana as in any other section of the country. No attempt has been made to go into detail as to how to meet every situation; merely an attempt to bring out the fact that our heads were made to think with. More time spent working out methods and less time spent griping about shortages of exact duplicates will "KEEP 'EM PLAYING."

**TRIPLITT**  
*Combat Line*  
**TESTERS**

TRIPLITT MODEL 1200 G TEST METER

RANGES — D.C. or A.C. VOLTS — 0-10-50-250-500-2,500 at 1000 ohms per volt.  
DIRECT CURRENT — 0-500 microamps 0-1-5-50-500 Ma. 0-1 amp.  
ALTERNATING CURRENT — 0-1 megohms.  
RESISTANCE — 0-30-10,000 ohms 0-1-10 megohms.

OUTPUT — Jacks and condenser in series with A.C. voltage ranges.

Although some older designs are no longer obtainable, several alternate models are available to you under Government requirements.  
TRIPLITT ELECTRICAL INSTRUMENT CO., BLUFFTON, OHIO



# "THE INDUCTANCE AUTHORITY"

By EDWARD M. SHIEPE, B.S., M.E.E.

THE ONLY BOOK OF ITS KIND IN THE WORLD. "The Inductance Authority" entirely dispenses with any and all computation for the construction of solenoid coils for tuning with variable or fixed condensers of any capacity, covering from ultra frequencies to the borderline of audio frequencies. All one has to do is to read the charts. Accuracy to 1 per cent may be attained. It is the first time that any system dispensing with calculations and correction factors has been presented.

There are thirty-eight charts, of which thirty-six cover the numbers of turns and inductive results for the various wire sizes used in commercial practice (Nos. 14 to 32), as well as the different types of covering (single silk, cotton-double silk, double cotton and enamel) and diameters of  $\frac{1}{8}$ ,  $\frac{1}{4}$ ,  $1\frac{1}{4}$ ,  $1\frac{1}{2}$ ,  $1\frac{3}{4}$ , 2,  $2\frac{1}{4}$ ,  $2\frac{1}{2}$ ,  $2\frac{3}{4}$  and 3 inches.

Each turns' chart for a given wire has a separate curve for each of the thirteen form diameters.

The book contains all the necessary information to give the final word on coil construction to service men engaged in replacement work, home experimenters, short-wave enthusiasts, amateurs, engineers, teachers, students, etc.

There are ten pages of textual discussion by Mr. Shiepe, graduate of the Massachusetts Institute of Technology and of the Polytechnic Institute of Brooklyn, in which the considerations for accuracy in attaining inductive values are set forth.

The book has a flexible fiber cover, the page size is 9 x 12 inches and the legibility of all curves (black lines on white field) is excellent.

Order from your dealer or direct—\$2.50

## GOLD SHIELD PRODUCTS

350 Greenwich St., (Dept. R.C.7), New York City

**RADIO AMATEUR COURSE**

By G.W. Shuart "W2AMN"

**RADIO & TELEVISION**

PRICE 50¢

148 PAGES

6 x 9 INCHES

OVER 150 RADIO DIAGRAMS and TECHNICAL PHOTOGRAPHS

RADIO AND TELEVISION

25 West Broadway New York, N. Y.

## PLANE-WRECKED AVIATORS SAVED BY "GIBSON GIRL"

(Continued from page 592)

cessories have been packed in two buoyant bags, strapped together. Now, however, a specially developed, waterproof container holds them compact and makes the outfit easier to handle.

The bags, painted a vivid yellow so they may be easily discerned in the water, contain the transmitter, a collapsible box kite, two deflated balloons, two hydrogen generators, two spare rolls of aerial wire and a signal light. Instructions and the telegraphic alphabet are imprinted on the top of the transmitter.

The Gibson Girl, itself, is equipped with wide webbing straps to secure it in a position between the legs of the operator. Power, generated entirely by hand, is gauged by an indicator light. When the indicator lights up brilliantly, the transmitter is literally yelling for assistance.

Even though the Gibson Girl has no receiving set, the chances of a plane crew's rescue are greatly enhanced because ocean

going vessels of all nationalities are required to maintain watch on the distress frequency.

A triple engineering job, calling for ingenuity in the fields of radio, mechanics and chemistry, was involved in perfecting the Gibson Girl.

Developing an efficient radio circuit was only one of many problems faced. Devised among other things during months of tireless experimentation were a lightweight, watertight transmitter case; a satisfactory generator for chemically producing hydrogen under the most adverse conditions; a powerful yet compact electrical generator and a collapsible kite.

An interesting outgrowth of the Gibson Girl's development has been formation of the "Order of the Gibson Girls." Eligible to membership are military personnel saved at sea through the device. New members of the order will receive a certificate and award of recognition.

## "STARS AND STRIPES OVER EUROPE"

(Continued from page 592)

who listens to these broadcasts does so at the risk of his life, as is well known. While no doubt our daily news broadcasts which the O.W.I. tries to keep scrupulously truthful, do some good, there is not sufficient listener coverage as a whole. It is almost certain that American broadcasts going out over English and North African transmitters

will do much more good, simply because they are on standard wave bands. Listening to these broadcasts entails no death penalty because radio listeners, whether in occupied countries or in Germany proper, tune in on the standard wave length on their regular radio sets. There is nothing that the Germans can do about it. Those who listen in to these transmissions will, of course, keep their loud speakers low and do it furtively, but inasmuch as the broadcasts are received in the citizens' own language, they can always give the excuse that they were tuning in to another station, if the Gestapo should be in the offing.

In the writer's opinion, while we are now trying to blanket Europe with the Stars and Stripes over the short waves, as far as truthful news is concerned, what we really need is a number of super-transmitters on standard wave lengths, both in North Africa and England. It would pay America to build such super stations, with a very large power output, that would COMPLETELY blanket most of the existing European—and particularly German stations.

To be sure the Germans are not asleep either and will try to blot out our British and North African broadcasts by means of their *Störseiders* (interference transmitters). In the past they were not always successful in doing so, as for instance with British transmissions, which get through in spite of the German interference.

It is to be hoped that U. S. super-transmitters can be made available soon. They will be worth their weight in gold and will no doubt shorten the length of the war by giving enslaved Europe facts and figures and other essential propaganda when we most wish all of Europe to listen to it.

### Your Money Back—

If the RADIO AMATEUR COURSE does not represent the greatest book value ever offered to the radio "fans" for ..... **50¢**

TO convince you that there isn't a better book buy today, the publishers of the RADIO AMATEUR COURSE make the sensational offer of a money-back guarantee on such a low-priced book. Stop in at any of the many dealers handling this book and examine it. See for yourself if the RADIO AMATEUR COURSE isn't just the book you've always wanted.

Printed on the finest coated paper—well illustrated attractive 4-color cover—complete with radio information you must have. It contains a step-by-step program for obtaining a short-wave radio education.

Written by George W. Shuart, W2AMN  
foremost short-wave authority

RADIO AND TELEVISION  
25 West Broadway, New York 7, N. Y.

Gentlemen: I enclose herewith my remittance of Fifty Cents (50¢) for which please send me POSTPAID, my copy of the RADIO AMATEUR COURSE. (Remit by check or money order; register letter if you send cash or unused U. S. Postage stamps.)  
PLEASE PRINT CLEARLY

Name .....

Address .....

City ..... State ..... RC-7-43

## WARTIME R.F. COIL DESIGN

(Continued from page 607)

basis of a coil of infinite length, so when it gets to the point where the diameter is a considerable fraction of the length, a correction is necessary. The values of K given in Fig. 2 will cover any shape of coil from one in which the length is 20 times the

diameter to one in which the diameter is 50 times the length.

**CALCULATING MULTI-LAYER COILS**

So much for the ordinary single-layer coil. But what of the numerous other types? These can all be calculated, from the loop antenna in the back of the midget radio to the toroid which was at one time hailed as the ultimate and final coil design.

The calculations for most of these tend to be somewhat complicated, and we will consider only the one likely to be used, the multi-layer ring-shaped coil of more or less square cross-section, such as is used in many R.F. and most I.F. coils, as well as practically all R.F. chokes.

At first glance it would seem that these could be calculated by the method already used. If doubling the number of turns in a single-layer inductance increases the inductance four times, the same increase should take place if the second half were wound on top of the first, instead of at the end. A little study of Fig. 3 will show us that the case of a multi-layer coil is somewhat different. Some of the turns (those at the inside and outside of the cylinder) are in much the same relative position they would be in the simpler coil—those near the center are not. Parts of the fields around some of these turns buck those around others, with the total result that the inductance is lower than would be given by our formula.

A rough method of arriving at the inductance of a coil of almost any shape can be used here. The formula is:

$$L = \frac{0.2 \ 2a^2 \ N^2}{6a + 9b + 10c}$$

All dimensions are in inches in this formula, and the inductance is in microhenries. By omitting the factor c, it can be used for single-layer coils. If you care to check it, you will find it gives the inductance of our previously-calculated coil as about 166 microhenries.

As an example, we will calculate the coil of Fig. 3. The measurements are given in centimetres. The mean diameter (2a) is something less than an inch, and the winding is slightly less than 1/4 x 1/4 inch in cross-section. For the purposes of our formula in inches we can call the dimensions:

$$2a = 0.866 \text{ in.} \quad N = 24^2 = 576 \text{ turns}$$

$$b \text{ and } c = 0.234 \text{ in.}$$

We then have:

$$L = \frac{0.2 \times .751 \times 332,000}{2.6 + 2.1 + 2.3} = \frac{49,870}{7}$$

or 7,110 microhenries, a little over 7 millihenries.

**THE MORE ACCURATE METHOD**

A more complicated system is to figure the coil out according to the standard formula for single-layer coils and apply a correction for the multi-layer feature. Our inductance then is:

$$\frac{0.0395 \times 1.1^2 \times 576^2 \times .394}{0.6} = \frac{6,270}{0.6} = 10,450 \text{ microhenries.}$$

The correction is a subtraction of the following:

$$\frac{0.0126 \ N^2 \ ac}{b} \times 0.7$$



# ONAN

## ELECTRIC PLANTS

Electricity for Any Job—Anywhere

★ ONAN GASOLINE DRIVEN ELECTRIC PLANTS provide electricity for all communications work in locations where it is not otherwise available, or for emergency and standby service. Thousands of these reliable, sturdy Plants are doing a winning job on all the fighting fronts, in communications and other vital war tasks.

We'll be glad to send details promptly on your present or post-war needs for Electric Plants.

**350 to 35,000 WATTS**  
A.C. 50 to 800 cycles, 110 to 660 volts.  
D.C. 6 to 4000 volts. Also dual A.C. and D.C. output models. Engines are air or water cooled. Model shown is from OTC series, air cooled.

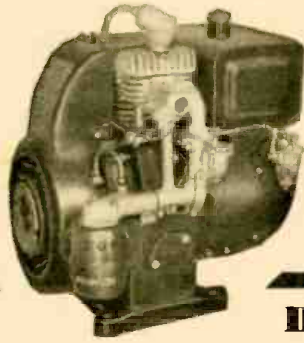

**D. W. ONAN & SONS**  
723 ROYALSTON AVENUE  
MINNEAPOLIS, MINN.

This gives us:

$$\frac{.0126 \times 332,000 \times 0.66}{0.6} \times 0.7$$

= 3,217. Subtracting this from 10,450 we have 7,233 microhenries, (differing not greatly from the simpler formula).

Further corrections make it possible to calculate with considerable accuracy coils of shapes approaching that of the single-layer coil, (such as bank-wound coils of 2 or 3 layers), or that of the flat disc, such as the pancake or spider-web coil. If the reader has need of such formulas and can use them, he is referred to the U.S. Bureau of Standards Circular 74. This circular was the source of most of the calculations in this article, though in some of them the extreme accuracy of the original has been sacrificed to make the formulas or charts simpler.

**SOME SOLDERING PITFALLS AND HOW TO AVOID THEM**

(Continued from page 606)

on large pieces such as chasses, it is better to use your plumber's iron, and keep your radio iron out of the paste.

This bit should be as big and heavy as possible, as at (b) in Fig. 2, whereas your regular radio iron should be a small, long-pointed type as at (a) in the same figure. The "hackett" bit at (c) is particularly useful for chassis work, its shape permits transferring a maximum of heat to the seams.

**SOLDERING PASTES**

Many experimenters may protest that they use non-corrosive soldering paste for all their radio work, and never have any trouble. This may well be true. The experience of the writer has been that it is impossible to tell by looking at a paste—or even by tasting it—whether it is certainly non-corrosive. It surely cannot be done by look-

(Continued on following page)

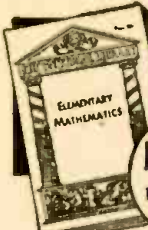

The Book that takes Drudgery out of Mathematics

Only 50¢ postpaid

Entire Chapter on Special Mathematics for the Radio Technician.

**ELEMENTARY MATHEMATICS**

● EASY — SIMPLIFIED — PRACTICAL ●

Here is the book that gives you a good background in mathematics; that takes all the irritation and drudgery out of it. You don't need to be scared of mathematics, because here's the subject explained without frills, without useless computations.

**CONTENTS OF BOOK**

- CHAPTER I. Arithmetic—Addition—Subtraction—Multiplication—Division.
- CHAPTER II. Factoring and Cancellation—Fractions—Decimals—Percentage—Ratio and Proportion.
- CHAPTER III. The Metric System.
- CHAPTER IV. How to Measure Surfaces and Capacity (Geometry).
- CHAPTER V. Powers and Involution—Roots and Evolution.
- CHAPTER VI. Mathematics for the Manual and Technical Craftsman—Thermometer conversions—Graphs or Curve Plotting—Logarithms—Use of the Slide Rule.
- CHAPTER VII. Special Mathematics for the Radio Technician.
- CHAPTER VIII. Commercial Calculations—Interest—Discounts—Short Cut Arithmetic.
- CHAPTER IX. Weights and Measures—Useful Tables.

**ONLY 50¢ POSTPAID**

Send today for your copy of this indispensable book. It can be carried readily in your pocket. (Size 9 1/2 x 6 1/2 in.)

Send Stamps, Cash or Money Order to

**TECHNIFAX**

1917 S. State St., RC-743, Chicago, Ill.

**TECHNIFAX** 1917 S. State St., Chicago, Ill.

Enclosed herewith 50 cents for which mail to address below your **ELEMENTARY MATHEMATICS**.

NAME .....

ADDRESS .....

CITY ..... STATE .....

RC-743

## SOME SOLDERING PITFALLS AND HOW TO AVOID THEM

(Continued from previous page)

ing at the label on the box! The safe way is to stick to rosin. It may sometimes be all right to use "strictly non-corrosive" paste for tinning the iron, if all the paste is carefully wiped off with a damp woolen rag (which every solderer should have at hand to keep his iron clean with).

Other metals can be soldered with special alloys, usually of the metal to be soldered and some other to reduce the melting point. If you have any special job to do, look up a book of formulas or ask someone who works with that kind of metal. (A jeweller usually knows a great deal about soldering). Aluminum is the extreme case of "keep the surface clean." Even with special

solders, it is very hard to solder this metal. This is because it oxidizes so quick that it is impossible to flux it. The only method is to clean it by rubbing with the tip of the iron under a coating of flux and special solder. When no air can reach the part during the cleaning process, the flux or solder has a chance, and a good job of soldering can be done.

This brings us back to the point we started out from, and which cannot be over-emphasized: **KEEP THE METAL CLEAN!** If the surfaces to be joined are free from dirt or oxide, and are hot enough to melt solder, you can't help making a good job!

## CROSS-MODULATION AS A FACTOR IN INTERFERENCE

(Continued from page 605)

Where strong and obstinate cases of local interference exist, the directly opposite method of attack can be resorted to by falling back upon the ingenuous Jones method of setting up an auxiliary antenna run to the source of the interference and using a phase-shifting condenser-and-coil network in this antenna circuit to feed in an out-of-phase noise signal into the receiver, letting the two antenna out-of-phase signals cancel out at the input circuit.

Obviously, not all interference problems present such complexity. They have been listed here in order that the radio man will be reminded of the many ramifications involved in the tracking down of elusive sources of radio interference.

# NEW RADIO-CRAFT LIBRARY BOOKS



THE four latest books of our well-known RADIO-CRAFT Red Books—Nos. 25, 26, 27 and 28—recently published. These four books are all on timely subjects and we recommend every one of them to you strongly. Now, more than ever, radio education has become a burning question. If you are to be in the National Service, in the Army, Navy or Air Force—practical radio knowledge is of paramount importance. YOU CAN GET BETTER RATINGS AND ADVANCE QUICKER IF YOU HAVE A GOOD RADIO BACKGROUND. Conversely, if you are not with the armed forces, there is a whole of a job to be done at home. With more and more men going into the service, the demand for practical servicemen becomes greater each day. Therefore we say: **PROFIT BY THESE UNIQUE BOOKS, WHICH ARE PRICED SO LOW THAT THEY ARE WITHIN THE REACH OF EVERYONE'S PURSE.**

### No. 25—Home-Made Radio Test Instruments

Outline of Contents: A Low-Cost Signal Chaser—Signal Tracer Test Unit—Simplified Practical Signal Tracer—A Home-Made Infinite Resistance Tube Checker—Build This Direct-Reading V. T. Voltmeter—How to Make a Modern V. T. Voltmeter—Measuring High Values of A. C. Voltage and Current With a Low-Range Meter—How to Make a Meter-Range Extender—How to Build a Practical Tube Tester and Set Analyzer Adapter—The Beginner's Simple Volt-Milliammeter—Build This Simplified Neon-Type Test Unit—Midtest Oscilloscope—How to Make and Use a Frequency Wobbler—Double Tracing Your Oscilloscope—Home-Made Frequency Modulator.

### No. 27—Modern Radio Servicing Technique

Outline of Contents: Elementary Servicing Technique—Correct Procedure for the Servicing Beginner—Elementary Procedure for Servicing Radio Sets—A. F. C. Alignment Made Easy—Dynamic Servicing—Dynamic Testing Simplifies Servicing—Modern Receiver Test Requirements—Servicing Universal A. C. D. C. Receivers—Servicing "Orphans" and Private-Brand Sets—Emergency Servicing Without Test Meters—Servicing Coils—Servicing R. F. Coils—Servicing Oscillator Coils—General Information—RMA Transformer Color Code—What Causes Echo, Fading?—Radio Service Puzzlers.

### SPECIAL SEND-NO-MONEY OFFER

It is not necessary that you send money with order. If you wish to take advantage of our C. O. D. Plan, simply cut out the coupon, paste it on a post card and send it to us. Books will be sent to you immediately. All four books are listed uniformly at 50c each. No discount on less than three books. If you wish to take advantage of our special offer, ordering three books or more, we make an unusual low price to you as follows:

3 books—\$1.25    4 books—\$1.50

Do not fail to send coupon today!

RADCRAFT PUBLICATIONS, INC.  
25 West Broadway, New York 7, N. Y.

### No. 26—Modern Battery Radio Sets

Outline of Contents: Beginner's 1-Tube High-Gain All-Wave Receiver—Beginner's-Build This 1-Tube Loop Receiver—A "3-in-1" Battery Portable—An Easily-Built "Flewwing" Superregenerative 2-in-1 "Card File" Battery Set—A 2-Tube Superhet. With Pentagrid Regenerative 2nd-Detector—The 4-Tube Superhet. Vacation Portable—The "Lunchbox 5" Battery Portable—"The Seafarer" Loop-Type Boat Radio Set—4-Tube Permeability Portable—An All-Purpose Portable—A Typical Commercial 3-Way Portable (Pilot Models X-1452 and X-1453)—Switch for Varying "C" Bias on Battery Radio Sets—Making a Simple Portable Aerial—Making a Pilot-Light Fuse—Old Auto Sets for New Cars—Using a Loop Portable in Cars—Quasi-Electric Soldering Iron—Lamp Bulbs as Resistors.

### No. 28—All About Frequency Modulation

Outline of Contents: The ABC of F. M.—Frequency vs. Amplitude Modulation—Basic Facts About F. M. Broadcasting—Construction—Build This Practical F. M. Adapter—Audio Amplification—F. M. Audio Amplifier, Part 1—F. M. Audio Amplifier, Part 2—F. M. Audio Amplifier, Part 3—F. M. Service—Part 1, Antenna Installation and Service—Part 2, Receiver Alignment and Diagnosis—Part 3, Test Equipment for F. M. Servicing, Engineering—Part 1, The How and Why of F. M.—Part 2, The How and Why of F. M.—Theory and Design Considerations of R. F. and I. F. Coils in F. M. Receivers.

RADCRAFT PUBLICATIONS, INC. 743  
25 West Broadway,  
New York 7, N. Y.  
Gentlemen:  
Rush to me by return mail, as per your special offer, the following books: (check books selected.)  
 No. 25  No. 27  No. 28  
I will pay postman \$1.00 (if two books are ordered), \$1.25 for three books, \$1.50 for four books, plus a few cents postage and charges.  
**WE CANNOT SEND A SINGLE 50c BOOK C. O. D.**

NAME .....  
ADDRESS .....  
CITY ..... STATE .....  
 Save shipping and C. O. D. charges! Check here if you send cash with order. (Cash, U. S. new postage stamps, money order, check.) Foreign countries no C. O. D. Add 20% to all prices quoted.

## IT STARTED IN LUXEMBOURG

It was somewhere about 1934 that the interference phenomenon known as "external cross-modulation" interference was first noted and described in radio literature. It was then known as the "Luxembourg Effect". The powerful European transmitter at Luxembourg caused unorthodox cross-modulation effects with nearby transmitters in adjacent countries. The various transmitter carriers involved were not harmonically related and no sound explanation could be advanced by continental radio men to account for the peculiar phenomenon. For a time, a non-linearity in the transmission medium and in the stratospheric Heaviside layers were suspected as being the non-linearity factors which caused the cross-modulation of the Luxembourg and nearby transmitter carriers.

About three years later, similar effects were noted in the U. S. and stations as much as 100 miles apart were found to be interfering with each other even though their carrier frequencies were not harmonically related.

It was eventually noted that the cross-modulation interference generally could not be effected appreciably in any way within the receiver or antenna circuits in themselves and that it was nearly always a factor completely external to the receiver in its origin. It was also noted that the effects often took place where long power and communication transmission lines were situated close to the interfering transmitters or else ran parallel to a line joining the interfering stations and where large metallic structures and transmission lines lay close to the radio receiver locations.

The conclusion was fairly obvious. Oxidized resistance-rectification joints and other non-linearity factors in the transmission line systems and metallic structures partially rectified the R. F. signals circulating within them, cross-modulated them and then re-radiated them to nearby antennas as multiple signals.

## AN AMERICAN ANALYSIS

Perhaps the first attempt at an accurate and experimental analysis of this phenomenon in this country was made by Foster of RCA and presented in a fine paper in the April 1937 issue of the *RCA Review*. He brought out the following points:

Two transmitter signals cross-modulated and re-radiated by some non-linear circuit external to both the transmitter and receiver systems may create some 12 harmonic and sum-and-difference (intermodulation) products where two of them are cross-modulations heard on each other's carriers. If only one strong carrier is present, the external non-linear re-radiator will gener-

ate only harmonics of this single carrier frequency.

Poor electrical connections in the receiver's power line, antenna and ground circuits and loose and corroded joints in nearby metallic structures and wiring systems will create this type of interference because of the presence of resistance-rectification joints in the systems. By inserting small rectifier tubes in series with ground or antenna leads, e.c.m. interference can be synthesized.

R.F. filters must usually be installed in the power lines feeding the radio equipment when e.c.m. interference is present. They are especially necessary at the point where the power feeders enter the building, otherwise the power system will re-radiate interference to other building wiring and metallic bodies which in turn will re-radiate to the receiver circuits. This power line filtering is particularly effective when a special form of e.c.m. interference, usually referred to as "tunable hum" or "power line hum", is present. This type of interference is a cross-modulation product of the 60 cycle power line frequency current and strong transmitter carrier currents circulating in the power transmission lines. These cross-modulation products get into the receiver amplifier circuits through the receiver power transformer mostly by capacity coupling. This hum nuisance often baffles many a radio man and causes hours of futile trouble-shooting, because its true nature is not generally understood.

**CROSS-MODULATION IS LOCALIZED**

E.c.m. interference usually exists in highly localized re-radiation fields and the simple expedient of shifting the receiver antenna or antenna lead-in about or simply relocating the receiver itself will often greatly decrease or totally eliminate this interference.

The following notes are facts which have been presented in radio literature in the past few years with regard to e.c.m. interference.

This interference may vary considerably in intensity with changes in weather conditions. The resultant variation of ground moisture content causes variations of earth conductivity and dielectric constants. It will also cause changes in the resistance-rectification conduction of corroded joints in wiring systems and metallic structures and in corroded metal-to-earth contact points.

The older the metallic structure or wiring system involved, the greater the trouble with e.c.m. interference. The reason for this is fairly obvious. The older the wiring system or metal structure, the greater the amount of corrosion in the joints, the greater the amount of rectification taking place and the more intense the cross-modulation effects.

Receiver antenna systems balanced to ground show little or no signs of e.c.m. interference since no sum-and-difference signals tend to flow in grounded circuits or circuits balanced to ground.

Much of the e.c.m. interference in the field of two or more strong signals is usually generated right in the receiver antenna, ground and power supply system. In the case of an A.C. receiver, this is especially true since power transmission neutral and ground circuits are notorious offenders in the way of rectification effects. (These points back up a suggestion made by the writer in the April 1937 issue of the old *Radio World*. The use of a three-wire power cord on A.C. receivers with which to ground the receiver chassis to the power line BX armor, as shown in Fig. 1, was advocated in order to reduce power line interference.)

**HOW THE POWER LINE INTERFERES**

A polyphase power transmission system's phase and line currents can be broken down into what are known as positive-phase, negative-phase and zero-phase components. The zero-phase components (also known as "residuals") are the worst offenders in the matter of radio and telephone interference since they are all in phase and transposition of the polyphase lines will not eliminate interference from these lines. Only an accurately balanced transposition of the telephone or radio antenna lines will eliminate or reduce interference from zero-phase components. A similar condition holds where the polyphase system has a neutral which is carry-

ing phase unbalance currents. Thus it can be readily seen why power transmission system neutrals and grounds may cause so much interference trouble in communications networks. Neutrals in "Y" connected polyphase transmission systems also encourage the generation of odd-order harmonics in the system, mostly 3rd harmonics, which are mostly generated by iron-core components, especially when over-loaded. These harmonics of the power frequency may cause intermodulation effects with the audio modulation of the radio transmitter carriers and further increase the noise and distortion effects of power line "tunable" hum.  
(Continued on following page)

**SUBSCRIBE NOW TO-**

**AND RECEIVE FREE THIS DICTIONARY**

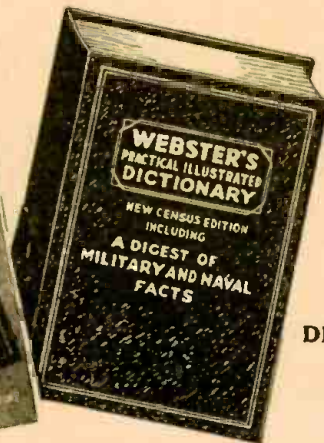

**FULL LIBRARY SIZE WEBSTER DICTIONARY 378 PAGES**

**FIVE MONTHS \$1.00  
TWELVE MONTHS \$2.00**

**SPECIAL NOTICE TO OUR READERS**

Due to wartime curtailment of paper, we are unable to meet the increasing newsstand demand for RADIO-CRAFT. We are therefore making this special introductory offer to our readers. Assure yourself of getting a copy of RADIO-CRAFT monthly by subscribing now and at the same time co-operate in making this wartime measure effective. Don't delay—Send in your order today. Take advantage of our special long-term offer and protect yourself against any possible increase in price by sending \$2.00 for 12 issues.

If you will take advantage NOW of our special subscription offer of five months for \$1.00 or twelve months for \$2.00, we will send you ABSOLUTELY FREE and POSTPAID this 378-page WEBSTER'S PRACTICAL ILLUSTRATED DICTIONARY—useful and instructive to all. This self-pronouncing authoritative dictionary—a brand new work throughout—contains the most up-to-date words now in common use. Over 20,000 definitions in all. In addition, it has the following: List of Largest Cities in the U. S.; List of Principal Cities of the U. S.; List of Principal Cities of Canada; National Parks of the U. S.; Time and Its Variations; Tables of Weights and Measures; Presidents of the U. S.; Synonyms and Antonyms; Dictionary of Commerce and Law; Dictionary of Forms of Address; Military and Naval Information (illustrated); Digest of the Purposes of Current Federal Agencies.

**THIS IS A TIME LIMITED OFFER**

**MAIL COUPON TODAY FOR A**

**SUBSCRIPTION AND DICTIONARY**

**RADIO-CRAFT  
25 WEST BROADWAY  
NEW YORK 7, N. Y.**



-----  
**RADIO-CRAFT, DEPT. 743,  
 25 WEST BROADWAY, NEW YORK 7, N. Y.**  
 Gentlemen: Enclosed you will find my remittance for which enter my subscription to RADIO-CRAFT Magazine for the period checked below. Send me ABSOLUTELY FREE and POSTPAID the Webster Dictionary.  
 5 months — \$1.00       12 months — \$2.00  
 This is a new order       Renewal  
 NAME .....  
 ADDRESS .....  
 CITY ..... STATE .....  
 Remit by check or money order; register letter if you send cash or unused U. S. Postage Stamps. (Canadian orders must be accompanied by an International Money Order.)  
 -----

## EXPERIMENTERS

The war has made a terrific inroad in practically all electrical and mechanical supplies. We are fortunate in being able to offer difficult to obtain merchandise listed below. As supplies are limited, we suggest that you order immediately before certain of the items are sold out. All of the attractive items listed here are brand new, except where indicated. ALL are in PERFECT WORKING ORDER. In many cases, the parts alone total more than the price we are asking. Satisfaction guaranteed or your money back.

ORDER FROM THIS PAGE. Use our convenient coupon. Include sufficient extra remittance for parcel post charges, otherwise order is sent express collect. Any excess will be refunded. All C.O.D. shipments require 20% deposit. NO C.O.D. shipments on orders for less than \$3.00. If full remittance accompanies order, deduct 2% discount. Send money order, certified check, or new U. S. stamps. No C. O. D.'s to foreign countries.

**ORDER TODAY LIMITED QUANTITIES PROMPT SHIPMENTS ASSURED**

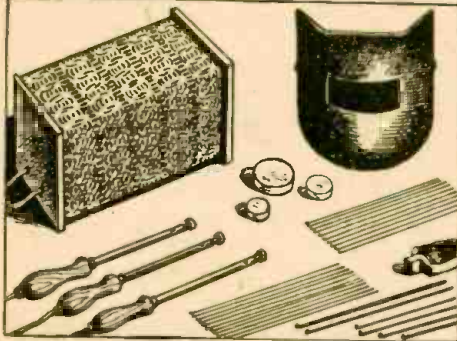

### THE MAGIC ELECTRIC WELDER

Here is one of the most compact, practical welders we have ever seen. Anyone can use it for shop, farm and home repairs. WELDS, BRAZES, SOLDER, CUTS ALL METALS. ANYONE CAN OPERATE IT. Repairs steel, cast iron, aluminum, brass, copper, bronze, etc. Complete with power unit, flame and metallic arc attachments. (Really two welders in one). Carbons, fluxes, rods, mask included. Just plug it in any electric outlet. 110 volts A.C. or D.C. For hobbyist or professional. GET IN ON THE GREAT WELDING BOOM. This fine set quickly teaches you welding. Low cost to operate—about 5c an hour. COMPLETE SAFETY is assured. No fumes with this outfit. SET COMES COMPLETE—nothing else to buy.

Used by the U. S. Navy, American Tel. & Teleg. Co.; Eastman Kodak Co.; Bell Laboratories, etc. BRAND NEW OUTFIT. Guaranteed for one year. Complete simple instructions with each set.

ITEM NO. 158 YOUR PRICE \$19.95

### WATCH-CASE MICROPHONE

This mike contains a unit like the famous, Skinderviken Button, mounted in a cast-aluminum case resembling a large watch case. A push-to-talk switch is mounted in the case. 200-ohm impedance. Works into any transformer designed for single-button microphones. Operates on one dry cell. Just the thing for home telephone sets, "home broadcasting," use with phonograph oscillators, etc. Case finished in black enamel. Slightly used. Size 2 3/4" by 1 1/2". Shipped postpaid.

ITEM NO. 156 YOUR PRICE \$1.00

### 100 POWER TELESCOPE LENS KIT

Make your own high powered 6 ft. telescope! Now you can thrill to a closeup view of the worlds out in space. See the rings around Saturn, the mountains of the moon! Kit contains 3" diam., 75° focal length, ground and polished objective lens and 2 astronomical eye-pieces, magnification 50x and 100x. Complete kit with full instructions.

ITEM NO. 123 YOUR PRICE \$2.45

### POWERFUL ALL-PURPOSE INDUCTION MOTOR IDEAL FOR EXPERIMENTERS—101 USES

Sturdily constructed to precision standards, this self-starting shaded pole A.C. induction motor is powerful enough for a large variety of uses. Some of these are: Automatic Timing Devices, Current Interrupters, Electric Fans, Electric Chimes, Window Displays, Photoell Control Devices, Electric Vibrators, Small Grinders, Buffers and Polishers, Miniature Pumps, Mechanical Models, Sirens, and other applications.

Consumes about 15 watts of power and has a speed of 3,000 r.p.m. When geared down, this sturdy unit will constantly operate an 18-inch turntable loaded with 200 lbs. dead weight—THAT'S POWER! Dimensions, 3" high by 2" wide by 1 1/2" deep; has 4 convenient mounting studs; shaft is 7/8" long by 3/16" diameter, and runs in self-aligning oil-retaining bearings. Designed for 110-20 volts, 50-60 cycles, A.C. only.

ITEM NO. 147 YOUR PRICE \$1.95

### WESTERN ELECTRIC BREAST MIKE

This is a fine light-weight aircraft carbon microphone. It weighs only 1 lb. Mike comes with breast-plate mounting and has 2-way swiveling adjustment so that it can be adjusted to any desired position. There are 2 woven straps; one goes around neck, the other around chest. Straps can be snapped on and off quickly by an ingenious arrangement.

This excellent mike can be adapted for home broadcasting or private communication systems. By dismounting breastplate, it can be used as desk mike. Comes complete with 6-foot cord and hard rubber plug. Finished in sherdarized plastic non-rustable.

THIS IS A BRAND NEW MIKE. IT HAS NEVER BEEN SOLD AT SUCH A LOW PRICE BEFORE. ORIGINAL LIST PRICE \$15.00. Shipping weight, 2 lbs.

ITEM NO. 152 YOUR PRICE \$2.55

### VARIABLE SPEED UNIVERSAL MOTOR

For 110 Volts, A.C. or D.C. All Nickel Plate Edison Dictaphone motor 1/50 H. P. Used out in excellent condition. For buffing, polishing, drilling, sawing; runs phonographs, fans, models, blowers, lathes, etc. Special control permits variable speeds up to 1800 r.p.m. 5/16" shaft extends from both sides of motor. Cast iron base has 3 screw mounting holes.



Height 4 1/2"; length 7 1/2"; width 5 1/2". Shaft is 1 3/4" long on one side. Shp. Wt. 8 lbs.

ITEM NO. 157 YOUR PRICE \$2.95

### POWER ADJUSTABLE RHEOSTAT

Here is an excellent rheostat used especially to regulate speeds of small motors, such as our Handy Workshop Outfit. This rheostat can be used in connection with motors up to 1/20 h.p. This fine rheostat is wire-wound on porcelain insulation. The black enamel steel casing is perforated for ventilation. Adjustable handle regulates speed of motor easily and smoothly. Size 5"x2 3/4" overall. Shp. Wt. 2 lbs.

ITEM NO. 153 YOUR PRICE \$1.45

### AMAZING BLACK LIGHT!!

Powerful 250-Watt Ultra-Violet Source

The best and most practical source of ultra-violet light for general experimental and entertainment use. Makes all fluorescent substances brilliantly luminescent. No transformers of any kind needed. Fits any standard lamp socket. Made with special filter glass permitting only ultra-violet rays to come through. Brings out beautiful opalescent hues in various types of materials. Swell for amateur parties, plays, etc. to obtain unique lighting effects. Bulb only. Shp. Wt. 1 lb.

ITEM NO. 87 YOUR PRICE \$2.45

### WATT HOUR METER

Completely overhauled and ready for immediate service. Designed for regular 110-volt, 60 cycle 2-wire A.C. circuit. Servicemen use it in their shops to check current consumption of sets, soldering irons, etc. Keeps costs down. If dismantled, the parts alone would bring the price. The elaborate gear train could be used as a counter on machines of various kinds. Simple to install; 2 wires from the line and 2 wires to the load. Sturdily constructed in heavy metal case, 8 1/2" high, 6 1/2" wide, 5" deep. Westinghouse, E. or Ft. Wayne makes. Shp. Wt. 14 lbs.

ITEM NO. 33 YOUR PRICE \$4.95

## CROSS-MODULATION AS A FACTOR IN INTERFERENCE

(Continued from previous page)

Furthermore, neutrals and ground return lines are completely unbalanced with respect to ground and this further encourages the generation of sum-and-difference inter-modulation products or c.c.m. interference.

Single-phase branch power networks are particularly troublesome, for two reasons. One is the fact that they tend to unbalance the feeding polyphase system and thus create neutral currents and the other is that they tend to develop unbalance frequencies with respect to ground, especially where one side of the line is the grounded c.t. of a single-phase 220-volt leg of a delta bank of single-phase transformers.

End of PART I

## A METHOD OF LOOKING AT R.F. OSCILLATORS

(Continued from page 604)

(so to speak) and a coil. Electrically, the two circuits are equivalent.

I could continue this with practically all our common oscillators, but I believe the idea can be grasped from what has already been said.

Remember, above all, that our really fundamental oscillator is the coil and condenser hook-up, and anything else added to it is for the purpose of keeping our oscillations steady. If you look at oscillators from that view point they lose their mystery very quickly.

## NOVEL FEATURE IN P.A. SYSTEM

(Continued from page 597)

It is necessary to talk within six inches of it to make announcements over the oscillator, under which condition it operates satisfactorily.

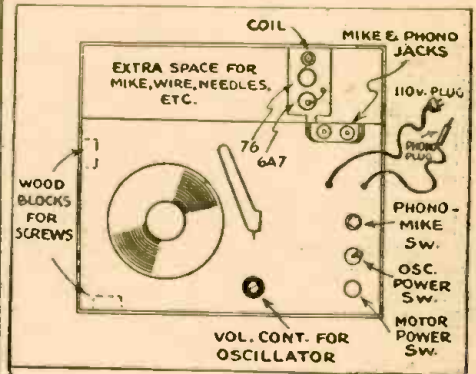

## A COMPLETE PORTABLE SYSTEM

The whole amplifier is encased in a box which measures 20 x 20 x 12 inches, as shown in the photo, and is thus a handy unit for portable work. The oscillator feature makes it useful for gatherings almost without limit as to the size of the hall.

The oscillator itself uses a standard circuit, and any phono oscillator could be used in its place. I used an ordinary broadcast coil with a small primary, then unwound a number of turns from the secondary and used an old condenser considerably larger than those now in use. This enables me to tune easily to a point right on the high or

## HUDSON SPECIALTIES CO., 40 West Broadway, N. Y. C.

IT'S EASY TO ORDER—CLIP COUPON—MAIL NOW ORDER FROM THIS PAGE.

HUDSON SPECIALTIES CO., 40 West Broadway, Dept. RC-7-43, New York, N. Y.  
I have checked below the numbers of the items I'm ordering. My full remittance of \$..... (include shipping charges) is enclosed. NO C.O.D. ORDERS UNLESS ACCOMPANIED WITH A DEPOSIT.  
OR my deposit of \$..... is enclosed (20% required), ship order C.O.D. for balance. NO C.O.D. ORDER FOR LESS THAN \$3.00. (New U. S. stamps, check or money order accepted.)  
Circle Item No. wanted: 33 87 123 147 152 153 156 157 158

Name ..... Address .....

City ..... State .....

Send remittance by check, stamps or money order; register letter if you send cash or stamps.



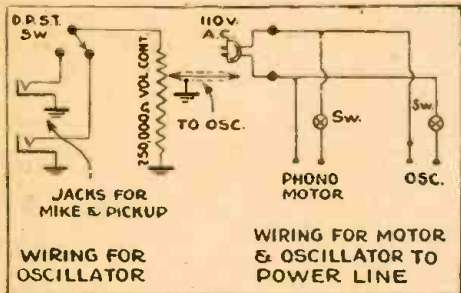

low edge of the range of any modern broadcast receiver.

It has its own power supply, using a 76 with plate and grid tied together as rectifier. Thus there is no possibility of coupling

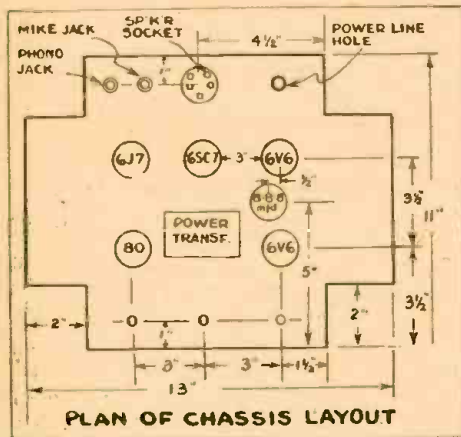

with the amplifier, as might be the case with a common power supply. I have actuated radios with it at a distance of 200 feet, though in practice this is never necessary.

CARRIER COMMUNICATIONS

(Continued from page 610)

It would indicate demodulation and must be corrected. Retuning the output circuits will usually correct this condition.

Parts List

- CONDENSERS
  - C1—Depending on Frequency to be used.
  - C2—Depending on Frequency to be used.
  - C3—.001 Mfd.
  - C4—.1 Mfd.
  - C5—.002 Mfd.
  - C6—.05 Mfd.
  - C7—.05 Mfd.
  - C8—.1 Mfd.
  - C9—.05 Mfd.
  - C10—.20 Mfd.
  - C11—.002 Mfd.
  - C12—.10 Mfd.
  - C13—.01 Mfd.
  - C14—.1 Mfd.
  - C15—.1 Mfd.
  - C16, C17, C18—Depending on Frequency used.
  - C19—.05 Mfd.
  - C20—.0001 Mfd.
  - C21—.1 Mfd.
  - C22—.30 Mfd.
  - C23—.20 Mfd.
  - C24—.10 Mfd.
  - C25—.1 Mfd.
  - C26—.1 Mfd.
- INDUCTORS
  - L1—Depending on Frequency to be used.
  - L2—Depending on Frequency to be used.
  - L3—Depending on Frequency to be used.
  - L4—Depending on Frequency used.
  - L5—Depending on Frequency used.
- RESISTORS
  - R1—10,000 Ohm.
  - R2—5,000 Ohm.
  - R3—10 Meg.
  - R4—2 Meg.
  - R5—.25 Meg.
  - R6—.5 Meg.
  - R7—500 Ohm.
  - R8—100 Ohm.
  - R9—.25 Meg.
  - R10—.1 Meg.

(Continued on page 638)

# Lowest Priced Publications for Experimenters

10 FOR 50c

Here is a large number of radio, short-wave, and mechanical "how-to-make-it" designs. Each is a special publication originated by masters in their respective fields. For the low price of 50 CENTS, you buy TEN complete pamphlets with photographic reproductions, complete mechanical layout, and full description to make it possible for anyone to build the project in question.

PLEASE ORDER EACH PROJECT BY ITS PUBLICATION NUMBER, and use the special coupon below. We accept money-orders, cash, checks or new U. S. stamps. (No foreign stamps.) If you send cash or stamps, register your letter. Money refunded if you are not satisfied. ANY TWENTY-FOUR PUBLICATIONS FOR ONE DOLLAR.

SHORT-WAVE RECEIVER PUBLICATIONS

- HOW TO MAKE THE "OSCILLODYNE" 1-TUBE WONDER SET. No. 101
- HOW TO MAKE THE "19" TWIN-PLEX (ONE TUBE PERFORMS AS TWO) RECEIVER. No. 102
- HOW TO MAKE THE WIZARD, 1-TUBE 50-WATT TRANSMITTER. No. 103
- HOW TO MAKE THE IMPROVED 3-TUBE DOERLE SET FOR BATTERY OPERATION. No. 104
- HOW TO MAKE THE "GO-GET-EM 2" RECEIVER FOR THE BEGINNER. No. 105
- HOW TO MAKE THE 1-TUBE-ALL-ELECTRIC OSCILLODYNE. No. 106
- HOW TO MAKE THE 2 TO 5 METER TWO-TUBE LOUDSPEAKER SET. No. 107
- HOW TO MAKE THE 3-TUBE BATTERY SHORT-WAVE RECEIVER. No. 108
- THE BRIEF-CASE SHORT-WAVE RECEIVER AND HOW TO BUILD IT. No. 109
- HOW TO BUILD THE POCKET SHORT-WAVE RECEIVER. No. 110
- HOW TO BUILD THE CIGAR-BOX 1-TUBE "CATCH ALL" RECEIVER. No. 111
- HOW TO BUILD THE "DUAL-WAVE" SHORT-WAVE BATTERY RECEIVER. No. 112
- HOW TO BUILD THE 1-TUBE "53" TWIN-PLEX" RECEIVER. No. 113
- HOW TO BUILD THE PORTABLE MINIDYNE SHORT-WAVE BATTERY SET. No. 114
- HOW TO BUILD THE HAM-BAND "PEE-WEE" 2-TUBER. No. 115
- HOW TO BUILD THE DUO-AMPLIDYNE. No. 116
- HOW TO BUILD THE "MOND-COIL 2." No. 117

RADIO BROADCAST RECEIVER AND SPECIAL RADIO PUBLICATIONS

- HOW TO MAKE THE A.C.-D.C. "CASH BOX" RECEIVER. No. 118
- HOW TO MAKE BEGINNER'S 2-TUBE ALL-WAVE SET. No. 119
- HOW TO BUILD THE "RADIO-LAMP" 4-TUBE TABLE RECEIVER. No. 120
- HOW TO BUILD A SUPER-SENSITIVE ALL-WAVE CRYSTAL SET. No. 121
- HOW TO BUILD THE 2-TUBE "PENTODE PORTABLE" BROADCAST SET. No. 122
- HOW TO BUILD THE RADIO "TREASURE" FINDER. No. 123
- HOW TO BUILD THE GERNSBACK ONE-TUBE PENTODE LOUDSPEAKER SET. No. 124
- HOW TO BUILD THE WORLD'S SMALLEST ONE TUBE BATTERY RADIO. No. 125
- HOW TO BUILD A 6-TUBE BATTERY ALL-WAVE "FARM PORTABLE" SET. No. 126
- HOW TO MAKE AN A.C.-D.C. ONE-TUBE "DEAF AID." No. 127
- HOW TO BUILD A PIANOTRON. No. 128
- HOW TO BUILD THE ONE-DOLLAR RADIO. No. 129
- HOW TO MAKE A VARIABLE-TONE CODE PRACTICE SET. No. 130

MECHANICAL PROJECTS PUBLICATIONS

- HOW TO MAKE A SOUTH SEA OUTRIGGER CANOE. No. 131
- HOW TO BUILD A PEE-WEE AUTOMOBILE. No. 132
- HOW TO BUILD A DUAL-CONTROL GLIDER. No. 133
- HOW TO BUILD A HOUSEBOAT ON PONTONS. No. 134
- HOW TO MAKE A BAND SAW FROM OLD AUTO PARTS. No. 135
- HOW TO BUILD A REAL LATHE FOR \$5.00. No. 136
- HOW TO BUILD A SAIL CAT-BOAT. No. 137
- HOW TO BUILD A SIMPLE PORTABLE REFRIGERATOR. No. 138
- HOW TO BUILD A XYLOPHONE. No. 139
- HOW TO BUILD THE ROWMOBILE. No. 140
- HOW TO BUILD LARGE TESLA AND OUDIN COILS GIVING 18-INCH SPARKS. No. 141
- HOW TO MAKE AN ARC WELDER. No. 142
- HOW TO USE AN A.C. ARC WELDER. No. 143
- HOW TO MAKE YOUR OWN MICROSCOPE. No. 144
- HOW TO MAKE A WIMSHURST ELECTROSTATIC MACHINE. No. 145
- HOW TO MAKE A POWER DRILL PRESS FROM SCRAP PARTS. No. 146
- HOW TO BUILD A GOOD LATHE FOR \$1.00. No. 147
- HOW TO MAKE AN EXPERIMENT WITH AN ELECTROPHOROUS. No. 148
- HOW TO MAKE AN ELECTRIC ARC-WELDER FROM AN AUTOMOBILE GENERATOR. No. 149

RADIO PUBLICATIONS, 25 West Broadway, NEW YORK 7, N. Y. RC 7

I enclose \$..... for the publications listed by number, at right, at the rate of 50c FOR ANY TEN PUBLICATIONS. NO ORDER FOR LESS THAN 50c ACCEPTED. \$1.00 for 24 publications. These publications are to be sent to me postpaid. I have placed a circle around each number which I want.

PLEASE PRINT CLEARLY

Name .....	Address .....	101	102	103	104	105	106
.....	.....	107	108	109	110	111	112
.....	.....	113	114	115	116	117	118
.....	.....	119	120	121	122	123	124
.....	.....	125	126	127	128	129	130
.....	.....	131	132	133	134	135	136
.....	.....	137	138	139	140	141	142
.....	.....	143	144	145	146	147	148
City .....	State .....						149

10 BEST RADIO BOOKS 10 CENTS EACH

- RADIO FANS EVERYWHERE—these fine ten cent text books give you an excellent foundation for the study of RADIO. They are clearly written, profusely illustrated and contain over 15,000 words in each book. You'll be amazed at the wealth of information contained in these handy books. Excellent for reference—ideal for every technical library. YOUR MONEY BACK if you are not satisfied. PROMPT SHIPMENTS
- No. 1—HOW TO BUILD FOUR DOERLE SHORT WAVE SETS
  - No. 2—HOW TO MAKE THE MOST POPULAR ALL-WAVE 1- AND 2-TUBE RECEIVERS
  - No. 3—ALTERNATING CURRENT FOR BEGINNERS
  - No. 4—ALL ABOUT AERIALS
  - No. 5—BEGINNERS' RADIO DICTIONARY
  - No. 6—HOW TO HAVE FUN WITH RADIO
  - No. 7—HOW TO READ RADIO DIAGRAMS
  - No. 8—RADIO FOR BEGINNERS
  - No. 9—SIMPLE ELECTRICAL EXPERIMENTS
  - No. 10—TELEVISION

BOOKS ARE ALL UNIFORM

Every book in the GERNSBACK EDUCATIONAL LIBRARY has 32 pages—with illustrations varying from 30 to 66 in number. Each title volume contains over 15,000 words. Positively radio's greatest book buy! If you do not think these books worth the price asked, return them in 24 hours and your money will be instantly refunded.

RADIO PUBLICATIONS • 25 WEST BROADWAY • NEW YORK 7, N. Y.

RADIO PUBLICATIONS, Dept. RC-743  
25 WEST BROADWAY, NEW YORK 7, N. Y.

Gentlemen: Please send immediately, POSTPAID, the book numbers circled below, I am enclosing ..... cents—each book being 10c.

Send FREE listing of 48 new 10c publications.  
PLEASE PRINT CLEARLY

Name ..... Address .....

City ..... State .....

Remit by check or money order—register letter if you send cash or unused U. S. postage stamps.

MAIL COUPON TODAY!

## We Salute— OUR Flag at War!

As a symbol—insuring the rights of Liberty, Freedom of Speech and pursuit of happiness. It is envied, respected and admired in every corner of the world as the guarantor of these rights.

We of Amplifier Co. of America are proud to serve and cooperate with all industry in solving war problems in the Audio-Radio-Radar-Electronic fields.

If we can help you, and we can if top-notch engineering is needed, get in touch with us.

**AMPLIFIER CO. of AMERICA**  
17 WEST 20TH STREET NEW YORK N. Y.

## Headset Headquarters CANNON-BALL



Circular C-7 covers complete line of sensitive, clear-tone, dependable Headsets. Get it. Choose the super-quality Headset you like best. Twenty years headset specialization insures satisfaction. Write

Scientifically Built Heavy bar magnets greatly increase their efficiency.

**C. F. CANNON COMPANY**  
SPRINGWATER, N. Y.

## LEARN CODE the way you'll be using it by SOUND



The best way to learn to read code is by listening to code. The best way to learn to send code is by hearing your own sending repeated back to you. With the new All-Electric Master Teleplex Code Teaching Machine, you learn code the natural, easy, fascinating way. Only instrument ever produced which records your sending in visible dots and dashes—then SENDS BACK your own key work at any speed you desire. There are NO PERFORATIONS—NO INK. Far superior to anything ever developed—a marvel of simplicity. That's why practically every school teaching code uses TELEPLEX. We furnish complete course, including the All-Electric Master Teleplex. Give you personal instruction with a MONEY BACK GUARANTEE—all at a surprisingly low cost. Write today for FREE CATALOG ST. No obligations.

**TELEPLEX CO.,** 107 HUDSON ST.  
JERSEY CITY, N. J.



HIGH EFFICIENCY  
Sound National Defense that is why NATIONAL DEFENSE SOUND SYSTEMS are equipped with University Reflex HIGH POWER LOUD SPEAKERS  
**UNIVERSITY LABS.**  
225 VARICK ST. N. Y. C.

## OPPORTUNITY AD-LETS

Advertisements in this section cost 20 cents a word for each insertion. Name, address and initials must be included at the above rate. Cash should accompany all classified advertisements unless placed by an accredited advertising agency. No advertisement for less than ten words accepted. Ten percent discount six issues, twenty percent for twelve issues. Objectionable or misleading advertisements not accepted. Advertisements for August, 1943, issue must reach us not later than July 15, 1943.

Radio-Craft • 25 W. B'way • New York 7, N. Y.

RADIO SERVICEMEN AND EXPERIMENTERS SEND for our giant radio catalogue. Save dollars. United Radio Co. (1000P) Newark, N. J.

USED CORRESPONDENCE COURSES AND TECHNICAL Books Bought, Sold, Rented, Catalog Free. Educational Exchange, Henagar, Alabama.

PENNY POST CARD BRINGS YOU LIST AND prices of radio supplies. John A. Cox wholesale radio service and supplies 557 Seventh Street, Parkersburg, West Virginia.

## AN ORGANIZATION FOR SERVICEMEN

Dear Editor:

Before the present war started and many of us servicemen were called to service and defense work it was necessary to repair and service many sets to arrive at a decent wage at the end of the week. It was the opinion of many servicemen that the only solution to the problem was a union which would force employers to pay a decent wage; at the same time keeping repair prices high enough to warrant such action.

Now that repair work is appreciated due to the lack of men it might be a good idea to try some means to keep the scale of prices for repairs at a fair level.

It is my opinion that after the war there will be many men getting back to service work. The sudden increase in the men available will naturally make it easy to acquire a good serviceman at a low wage. One thing leading to another it will not be long before the wage scale will be down in

the brackets of unskilled help.

The fact is that the same amount of men will be hired but due to the availability of men the employer will be in a position to pay just what he happens to want to. I would rather see myself out of the business entirely than try and compete with another man who was working for his health, as it were.

Your magazine has brought out many good ideas and helped servicemen and others in the radio field many times in the past. How about starting this movement now or at least get the opinion of others on the subject. I have talked to many men who would favor it. Of course, local conditions will have an effect on the idea but it would be worth a few lines in your magazine just to see what opinion others may have on this subject.

G. THODEN,  
Asbury Park, N. J.

## PROPAGANDA VERSUS GOOD-WILL

Dear Editor:

After months of futile search, today I spotted a copy of *Radio-Craft* on the newsstand. In it I read the letter "Short-Wave Listeners" signed by Mr. Elmer R. Fuller of Cortland, N. Y. This letter interested me very much because from April, 1936, I have been until recently a very keen short-wave listener, both for regular entertainment and for Dx-ing.

At that time I was living in my home country of British Guiana.

About 95% of our radio entertainment came from the U.S.A. over stations W2XAF, W2XE, W8XK at night and W2XAD, W3XAL, W2XE and W8XK in the daytime. The mere mention of these former call letters brings back haunting memories of the good old days when it paid high dividends in radio entertainment to invest in a good receiver capable of bringing in those stations.

Now, with the U. S. stations more powerful than ever, they are being used for ramming propaganda down the ears of—whom? The few fanatics scattered around, perhaps? A person can no longer tune in Schenectady, Bound Brook or Wayne and sit back comfortably to enjoy the dividends on the money he invested in his radio by way of a good evening's entertainment. He must put up with a barrage of propaganda in the hope of hearing a few dance records.

You might well ask, "Haven't you British people got the B.B.C.?" My answer is that if you are in the habit of listening to your local stations there in New York you are listening to the world's finest radio entertainment. No combination of radio programs anywhere else in the world can match the entertainment value to English-

speaking people of the American radio programs (which are no longer being relayed over the shortwave transmitters).

One wouldn't mind the propagandists jabbering away if *only one* of the short-wave transmitters in Schenectady, Philadelphia or Boston were permitted to relay N.B.C. and/or C.B.S. programs during the evening hours.

I want the Allies to win; I know they must win and will win, or all the remaining freedoms will be taken away—but I do not need propaganda. "But," the powers that be might say, "if you don't need propaganda there are others that do." To that I would answer, "I am not asking you to stop emitting propaganda—what I am asking is that one short-wave station be left free to air some of the network programs and you can blast away all you like over the others." No amount of fascist propaganda can make me a fascist; no amount of communist propaganda can make me a communist; and no amount of any kind of propaganda can make me a nazi.

GEORGE C. WHITNEY,  
Aruba, N. W. I.

(Mr. Whitney's letter is certainly an eloquent tribute to the "propaganda" effectiveness of the North American stations in the old days. How far his conclusions as to the present situation are justified is a more controversial matter. It is one which should, however, be settled by our Spanish-speaking South American readers, as the English-speaking S.W. enthusiasts are in a small minority, and most of them are, like Mr. Whitney, of a type not easily swayed by propaganda. What have the Spanish-speaking section of the South American short-wave fans to say about this?—*Editor.*)

## THIS SERVICEMEN AGREES WITH EMBREE

Dear Editor:

Referring to the May issue, I agree with Mr. B. W. Embree. I too believe that a serviceman should take on a boy who is interested in radio to do small jobs around the shop.

I have been servicing radios only since March 1942 and at present am taking the N.R.I. course. During the past four years I have contacted numbers of boys and tried

to get them interested in radio. So far I have only one interested, and he is REALLY interested.

Speaking of servicing 15 to 20 sets in an eight-hour day—it would be a fair-sized job to service or repair that many crystal sets! What say Mr. Embree?

VIVIAN KINARD,  
Big Spring, Texas

**RADIO-CRAFT SUITS HIM**

Dear Editor:

I have just finished reading the very interesting March issue. I believe your magazine the best radio magazine ever published. It has wonderful experiments for beginners, very educational articles for us "Old Timers" and grand helpful items for us servicemen.

About the letter from Elmer R. Fuller of Cortland, N. Y., I am very much interested in his ideas. If possible, please publish more of his material.

If possible, give us more dope on Electronics. I have taken your advice in the Book Review Section and have ordered the book you recommended: "Experimental

Electronics." I am sure I will learn the fundamentals of this very interesting subject.

The one-tube A.C.-D.C. receiver shown in the Radio Experimenter's Section is similar to one I have used in my shack, when we hams were on the air.

I have a son very much interested in radio and he finds the Beginner's Articles very helpful. Please keep up the good work, helping the beginner get a good fundamental knowledge of radio.

I hope you will be able to continue to publish your grand magazine. Wish you lots of good luck.

JOHN M. DEFACE, JR.,  
Dallas, Texas.

**LIKES DIAGRAMS**

Dear Editor:

For over a month now I have been looking for a diagram of a phone oscillator using a type 1A7GT tube. At last I have found it, and I have you to thank for it.

I am a radio operator at a truck and trailer detachment, and we have managed to save a few old parts from civilian sets. I had already started to build a set, but I am not "up" on my radio as I used to be, and so I was stuck a little. Now I think I am all set to go ahead and build it up. I am going to try using the full 90 volts for more push.

I have found your magazine very interesting, and if ever I get back to civilian life will try some of the many good circuits I have seen. I intend to save the books and send them home for future use.

I was a radio serviceman in civilian life and have forgotten quite a bit. Your magazine has refreshed my mind very much. My main line as a serviceman was sound engineering.

I will be glad to get back to it when the war is over.

PFC. WALTER L. AMEIGH,  
Parsonsburg, Md.

**REMEMBERS MODERN ELECTRIC ARTICLES**

Dear Editor:

Just purchased the April issue of *Radio-Craft* and have glanced over some of the Letters to the Editor and some of the articles. I purchase a copy now on the average of twice a year to see what is transpiring in Radio—and to take me back some 33 years to when I was a subscriber to *Modern Electronics*.

What prompted me to write was a thoughtful letter to you about the article on Tesla. I can tell your correspondent that

you have always written friendly articles on the great and the near great, giving each credit for his good works and never a slight.

I like your constant attitude of assistance to all and sundry.

Some time when I am in New York I plan on giving you a call—I would like to meet you. Here's wishing you continued health and fun—I know you must enjoy what you have been doing for over 30 years.

JACK NUTTER,  
Toronto, Canada

**LIKES "HINTS AND KINKS" SECTION**

Dear Editor:

I want to tell you how much I enjoy your "Radio Kinks" page. Because of the shortage of parts, the ideas presented there are often invaluable to the radioman. It is such presentations (that really are usable) that make *Radio-Craft* just a little bit better than others in your field.

May I suggest that, when you receive enough of these kinks, you publish a new *Radio-Craft* Library book, devoted entirely to Hints and Kinks?

In closing, I am enclosing a Kink of my own.

GEORGE MURAKAMI,  
Newell, Calif.

**HOW MANY RADIOS PER DAY?**

Dear Editor:

I disagree with Mr. Embree where he takes issue with Mr. Buck on servicing 15 to 20 sets in an 8-hour day.

He claims this is a foolish statement by Buck, and that it would take almost that time to test the tubes alone, without doing any other work whatsoever.

I think the foolish statement is by Mr. Embree. If he can't work faster than that, he can't make a living in the radio-servicing game. (Unless he puts the old "gypper," as he calls it, on some customer.)

He also speaks of licensing servicemen. Well and good, if it will raise the serviceman's wages. However, a serviceman is

paid for what he can do and what he knows, whether he is in his own business or working for someone else. A man has to know his stuff to make a go of it today!

If you can't meet competition, you will fail, especially if your inability to meet competition is caused by inadequate knowledge of the subject or product you are trying to service or sell.

Then why worry about licensing the Serviceman? If incompetent, he will eliminate himself.

Hats off to (Bring 'Em Back Playing) Buck, also to Willard Moody.

HERBERT NOONES,  
East St. Louis, Ill.

**TECHNICAL BULLETINS**

Technical bulletins give reliable information in easy-to-follow form, and save valuable time otherwise spent in laborious reading of numerous books. Every subject is treated briefly and concisely, yet completely. No complicated mathematics, chemistry, electricity, or theory. Each bulletin is written in simple language.

Each Bulletin consists of a set of large sheets, assembled in one packet, size 9 x 14 1/2"; weight 1/4 lb. Numerous illustrations, diagrams, charts to supplement text.

PRICE \$1.00 EACH POSTPAID  
ORDER BY NUMBER

- D-111—DESIGNING AND BUILDING TRANSFORMERS
- D-112—DESIGNING ELECTRO-MAGNETS
- D-113—HOW TO DESIGN SOLENOIDS AND PLUNGER MAGNETS
- D-101—USING NICHROME RESISTANCE WIRE
- D-106—REWINDING ELECTRIC MOTORS
- D-144—ALTERNATING CURRENT CONTROLLED WITH EASILY MADE CHOKE COILS
- D-148—DESIGNING AND USING ELECTRIC RELAYS
- D-127—SMALL ELECTRIC LIGHT PLANTS
- D-134—ELECTRICAL EXPERIMENTS WITH SIMPLE MATERIALS
- D-131—MODEL MAKERS & INVENTORS GUIDE TO REMOTE-CONTROL SWITCHING
- D-137—ELECTRICAL METERS EASILY BUILT
- D-136—SMALL A.C. ARC WELDER CONSTRUCTION AND USE

Send Stamps, Cash or Money Order

**TECHNIFAX**

1917 S. STATE ST. RC-743 CHICAGO, ILL.

DEPT. RC-743  
TECHNIFAX 1917 So. State, Chicago, Ill.

Enclosed find \$..... for which please send me postpaid the following Technical Bulletins:

Nos. ....

Name .....

Street and Number .....

City and State .....

**RADIO AND ELECTRONIC DEVICES**



**BURSTEIN-APPLEBEE CO.**  
1012-14 McGee St. Kansas City, Mo.

# • ADVERTISING INDEX •

## Inventions Wanted Patented or Unpatented

We have been successfully selling inventions, patented and unpatented, since 1924. Write us, if you have a practical, useful idea for sale.

**CHARTERED INSTITUTE  
of AMERICAN INVENTORS**

Dept. 109, 631 Pa. Ave., N. W., Washington, D. C.

## PATENTS—TRADE MARKS

Booklet concerning Inventions & Patents Form "Evidence of Conception" with instructions for use and "Schedule of Government and Attorneys Fees"—Free  
**LANCASTER, ALLWINE & ROMMEL**  
Registered Patent Attorneys

436 Bowen Bldg. Washington, D. C.

## Basic Facts on Electricity Needed to Understand Electronics!

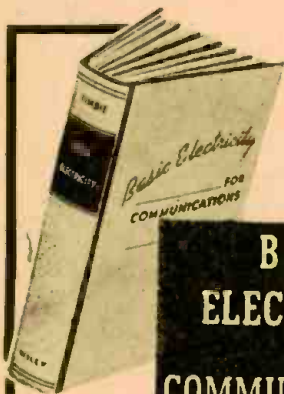

603 pages  
\$3.50

## BASIC ELECTRICITY for COMMUNICATIONS by W. H. TIMBIE

A clear, concise, practical book for those who want to prepare themselves now for the rapidly growing fields of Communications and Industrial Electronics.

Only those facts and principles every communications or electronics worker needs to know—and know well, are presented. Actual job problems are used throughout to show, step by step, how to solve electrical and communications problems that arise in practice.

This book gives you a comprehensive picture of the fundamental laws and principles governing communications practice. You will know the instruments and apparatus used—what they look like—how they work. You will know the symbols and language of the trade, and learn to figure quickly daily problems. This book will give you a foundation that will serve you well at all times and prepare you for advanced work in the field.

### -----ON APPROVAL COUPON-----

JOHN WILEY & SONS, INC. RC-7-43  
440 Fourth Avenue, New York 16, N. Y.

Please send me a copy of Timbie's BASIC ELECTRICITY FOR COMMUNICATIONS on ten days' approval. At the end of that time, if I decide to keep the book, I will remit \$3.50 plus postage; otherwise I will return the book postpaid.

Name .....

Address .....

City and State .....

Employed by .....

## CARRIER COMMUNICATIONS

(Continued from page 635)

R11—500 Ohm.  
R12—50,000 Ohm.  
R13—1. Meg.  
R14—1. Meg.

### MISCELLANEOUS

Speaker, P.M.  
SW1—3P—DT.  
SW2—Power SW.  
AA, BB—Terminal Posts.  
CH1—Filter choke, 400 ohms.  
CH2—Audio choke, 400 ohms.  
T1—Power Transformer.  
T2—Coupling Transformer.  
2—6V6, 1 each 6SJ7, 6B8, 5Y3, tubes.

### COIL DATA FOR 25 KC.

All coils are universal-wound on dowels  $\frac{5}{8}$  inch in diameter and  $2\frac{1}{4}$  inches long.

L1—720 turns 10/38 Litz, width of winding  $\frac{3}{4}$  inch.

L2—240 turns 10/38 Litz, width  $\frac{3}{16}$  inch, L1 and L2 are wound in opposite directions.

L3—720 turns 10/38 Litz, width  $\frac{3}{4}$  inch, spaced  $\frac{1}{16}$  inch from L1.

L4, L5—1080 turns 7/41 Litz, width  $\frac{1}{2}$  inch. (L6 has 2 identical windings, 1080 turns each).

A—150 turns 10/38 Litz, width  $\frac{1}{2}$  inch.

B—2 to 3 turns No. 20 solid wire, insulated.

The condensers used on this intercommunicator were variable between .003 and .006, being padded up to the minimum figure with mica. For a more limited range of frequencies, .001 variables may be used, with mica condensers to bring the total capacity to within the desired working range.

## SECOND SCRAP RECORD DRIVE WILL START JULY FIRST

**RECORDS** for Our Fighting Men, Inc., a not-for-profit organization of the nation's leading musical artists, today announces that its second nationwide house-to-house drive to collect old or unwanted phonograph records will take place July 3 to July 31.

The old records collected (it is estimated that there are still more than 200,000,000 old broken or unwanted discs accumulating dust in America's attics and cellars) will be sold to phonograph record manufacturers as scrap at ceiling prices. With the funds thus obtained, Records For Our Fighting Men, Inc., will continue to purchase hundreds of thousands of newly released recordings at lowest factory prices for distribution to our fighting forces, here and overseas, in cooperation with Army and Navy authorities.

Enough scrap records were collected during last year's drive by Records For Our Fighting Men, Inc., to enable its directorate to purchase more than 300,000 new popular and classical discs, to date, for shipment to Army Camps, Naval and Coast Guard stations, and Marine bases on several continents.

**A** MERICAN flyers in the Pacific, constantly bombarded with radio programs of not-too-great technical excellence from Radio Tokyo, have retaliated by addressing a "fan letter" direct to Tojo.

Among other things they urge the Premier to either change the theme song to something other than "My Bonnie Lies Over the Ocean," or have the Tokyo station's piano tuned so that it can play that piece of music.

It was suggested that the letter would be handed to the International Red Cross for transmission via its Berne agency, but there is also the possibility that the boys will fly it to its destination, and drop it (among other things) direct to Premier Tojo.

## ELECTRONICS

Engineers  
Laboratory Assistants  
Production Men

### Well Paying War Job Plus Peace Time Career!

Ideal working conditions with expanding manufacturers now at war work and planning peace time developments. Unlimited opportunity for an important place in a New World of Radio.

Men employed at full skill in war industry should not apply!

All others write Today!

PANORAMIC RADIO CORP.

242 West 55th Street

New York

New York

## USED Correspondence Courses

COMPLETE HOME STUDY COURSES and self-instruction books, slightly used. Sold, rented, exchanged. All subjects. Satisfaction guaranteed. Cash paid for used courses. Full details and 84-page illustrated bargain catalog FREE. Write today!

NELSON COMPANY, 321 S. Wabash, Dept. 210, Chicago

## Index to advertisers

Allied Radio Corp. ....	626
Audel & Company .....	Back Cover
Audiograph .....	623
Amplifier Company of America .....	636
Burstein-Applebee .....	637
Cannon Company, C. F. ....	636
Chartered Institute of America .....	638
Echophone .....	615
Gold Shield Products .....	630
Hallcrafters, Inc. ....	
..... Inside Back Cover, 580	
Harrison Radio .....	628
Henry Radio .....	629
Hudson Specialties .....	634
International Resistance .....	579
Lancaster, Allwine & Rommel .....	638
Meissner Manufacturing Co. ....	625
National Schools .....	627
National Radio Institute .....	577
National Union Corp. ....	617
Nelson Company .....	638
Onan & Sons, D. W. ....	631
Opportunity Adlets .....	636
Panoramic Radio Corp. ....	638
Popular Homecraft .....	628

## RADIO SCHOOL DIRECTORY Page 640

Candler System  
Capitol Radio Engineering Institute  
Commercial Radio Institute  
Lincoln Engineering School  
Mass. Radio School  
New York Y. M. C. A. Schools  
RCA Institutes  
Radio-Television Institute

RCA Laboratories .....	608, 609
Radcraft Publications, Inc., .....	
..... 619, 632, 633	
Radio Publications .....	635
Radio & Television .....	630
Sprague Products .....	613
Sprayberry Academy of Radio .....	624
Supreme Instruments .....	628
Supreme Publications .....	

### Inside Front Cover

Sylvania Electric Co. ....	622
Technifax .....	637
Teleplex .....	636
Triplett Electrical Instrument Co. ....	629
University Laboratories .....	636
Wiley & Sons, John .....	638

(While every precaution is taken to insure accuracy, we cannot guarantee against the possibility of an occasional change or omission in the preparation of this index.)

# BOOK REVIEWS

**FIRST PRINCIPLES OF RADIO COMMUNICATIONS**, by Alfred P. Morgan. Published by Appleton-Century Co. Stiff cloth covers,  $5\frac{1}{2} \times 8\frac{1}{2}$  inches, 366 pages. Price \$3.00.

A clean break is made with the old school-text type of book in this elementary instruction book, intended for beginners interested in the communications field.

Even though the chapter headings are orthodox, the very first chapter, Static Electricity, shows a picture of a group of electrons clustered around their nucleus nearly three pages before the familiar figure of the glass rod and silk rag.

A similar modern approach is shown throughout the remaining chapters on electrical and radio theory. Among primary electric generators, (found here in the second chapter, as in all traditional electrical texts) we find a simple diagram of a thermo-couple, and a cut of a photo-electric tube, with a description of its action. The piezo-electric crystal is also given its rightful place as a generator of electricity, and some of its more important uses are catalogued.

The chapter on Current Flow similarly devotes part of its space to current flow in liquids, or electrolytes, in gases and in vacuum.

The advance in the needs of radio students over recent years is demonstrated in the Fundamental Direct Current Calculations of Chapter 6, where Kirchoff's Law is introduced simultaneously with Ohm's.

The chapter on electrical measuring instruments is very clearly written, with some cuts which actually reveal the workings of the meters illustrated.

After handling electron tubes; condensers and resistors as used in radio circuits; electromagnetic waves; tuning and resonance; electron tubes as used in detector and amplifier circuits, including modern multi-electrode tubes; and telephone receivers and speakers, the author deals with radio receivers at far greater length than in many books of this type, introducing the communications motif of the work.

The chapter on radio receivers is followed by one on transmitters and the use of electron tubes as radio-frequency generators. Circuits of simple transmitting circuits are shown. So also are all the old basic oscillator circuits, beginning with the Hartley, up to and including crystal and transistor oscillators. The next chapter deals with keying the transmitter. This is followed by a short chapter on radiotelephony, chiefly dealing with microphones.

Mr. Morgan has long been able to put his books into language easily understood by the beginning student, and now carries the "beginner's book" to a more advanced point than most such works previously attempted. As such it will no doubt find an important place to fill among communications students with no previous knowledge of radio.

**PRINCIPLES AND PRACTICE OF RADIO SERVICING**, by H. J. Hicks. Published by McGraw-Hill Book Co. Stiff cloth covers,  $6 \times 9$  inches, 391 pages. Price \$3.50.

The author calls attention to the fact that the advance made in radio receivers during the past five years necessitates an

entirely new type of serviceman. Volume expansion, automatic tuning, wireless remote tuning controls, the use of high-frequency power supplies such as those in light-beam phonograph pickups, all act to eliminate the "serviceman" equipped only with a few tools and a smattering of radio knowledge.

The necessity for technical knowledge on the serviceman's part must increase with the spread of FM and television. Those practical men who are still keeping more or less abreast must increase their knowledge of radio fundamentals if they wish to hold their own in this rapidly-changing field. It is for these that this book is written.

The work starts in the accustomed manner, with fundamentals of electricity and magnetism. The service slant is visible as early as the second chapter, when the discussion of capacity and inductance refers directly to radio condensers and coupling.

Treatment of radio tubes, power supplies, test equipment (both practical use and principles of operation) and volume, tone and frequency controls receive a very full treatment, whereas the more theoretical chapters on radio and audio-frequency amplification, detection, and the superheterodyne, are dealt with more briefly.

Antennas, including installations for frequency-modulation receivers, receive a chapter. Another short chapter is devoted to the frequency-modulation receiver itself.

A long chapter is devoted to servicing problems and methods, beginning with correct soldering and running to servicing inverse feed-back circuits and automatic frequency controls.

Public-address systems also receive full treatment, with notes on microphones of all types, mixer circuits, impedance matching, constant-impedance attenuators and monitors.

This book will be found especially useful to two groups; the practical radio man who wishes to understand more of the fundamentals underlying the operation of the apparatus on which he works; and the student who has some knowledge of radio theory and wishes to apply it to practical servicing.

**THE MATHEMATICS OF WIRELESS**, by Ralph Stranger. Published by the Chemical Publishing Co. Stiff cloth covers,  $5\frac{1}{2} \times 9$  inches, 215 pages. Price \$3.00.

This work by the distinguished English author of popular radio books makes no attempt to give intensive instruction in any branch of mathematics. Rather is it his intention to disperse the fear the usual radioman has for all mathematical subjects, to show him their essential reasonableness and inherent simplicity, then to send him, fortified by the introduction, to the standard texts on the various branches of the subject.

The author does not express an open contempt for the "schoolmen" of mathematics as does his fellow-countryman Hogben, but does make it quite clear that in his opinion, the chief difficulty faced by the student is not in the subject, but in the methods used by mathematics teachers in standard educational institutions. Accordingly, the reader is given a "nibble" at all

the standard branches of the mathematical mystery, beginning with common fractions and going right through to integral calculus.

Radio applications of each of these branches are made immediately, the student using the fractions of the first "nibble" to calculate series and parallel connections of condensers, inductors and resistors. A.C. mathematics is handled in two chapters, Kirchoff's Law is used, and there are chapters on curves and graphs in radio, as well as a number of formulas concerning coil design, reactance and other electrical quantities.

The chapter on the slide-rule, which we consider a feature of the book, is illustrated by three large double-sided inserts, in which parts of the rule are shown larger than natural size.

Though essentially a "wireless" book, the style, presentation and scope make it an excellent introduction to mathematics for the general reader. Stranger's popular style carries over into his mathematical writing, with the result that this book can be understood by many who have difficulty even with the standard "Introductions to—" this or that branch of mathematics. For the radioman who wishes to improve his mathematical knowledge, it is an outstanding work.

**SIMPLIFIED RADIO SERVICING BY COMPARISON METHOD**, by M. N. Beitman. Supreme Publications. Stiff paper cover, size  $8\frac{1}{2} \times 11$  inches, 108 pages. Price \$1.50.

In view of the impossibility of obtaining many types of test instruments, the new servicemen, who are taking the places of many engaged in important war work or with the armed forces, will be pleased to learn of these methods of servicing with a minimum of instruments.

The inexperienced man will be further helped by the insistence on comparison. More than one young serviceman has been startled to see an older worker refer to a standard service manual while working on an "orphan" set. This book points out that there are only a few circuits, and that the standard circuits printed on its pages can be used by the intelligent serviceman to assist him on receivers with a wide variety of brand names.

Another helpful feature is the series of tests to be made with simple devices, such as a 200-ohm and a 250,000-ohm resistor, a small electrolytic condenser, and that most dependable instrument of the old-time serviceman—a moist finger. Charts are provided indicating points at which tests should be applied, and the reaction to be expected if the part is good, or if otherwise.

While emphasizing simple methods, involved circuits are dealt with, and there are pages explaining a.v.c., a.f.c., vibrators, etc., as well as the more advanced types of multi-tube, multi-band receivers. The use of test instruments is also explained for those who happen to have access to them.

The printing is done in mimeograph style. A large number of excellent cuts, and the blue-printed full-page standard comparison schematics are pleasant features of the book.

# RADIO SCHOOL DIRECTORY

## DEVELOPS LENARD RAY FOR PRACTICAL WORK

DR. CHARLES M. SLACK, recently appointed assistant director of research at the Westinghouse Lamp Division, is known for his development of the interesting and mysterious Lenard-Ray tube. Known to science for many years, the Lenard-Ray tube was little used, due chiefly to technical difficulties.

Dr. Slack's tube is the most practical form of the instrument to be developed to the present date. By means of the Lenard-Ray window—thin as a soap-bubble—electrons from the interior of a high-voltage cathode-ray tube are shot out into the air at a speed approaching that of light.

These electrons are deadly to life in their path, and are used with excellent effect in the treatment of local skin infections, in-

stantly killing living cells which might require several minutes of exposure to X-rays for the same effect.

The Lenard-Ray tube also makes possible for experimental purposes the turning of certain oils into solids or reforming the crystal structure of table salt.

Dr. Slack is also well known in the field of electronic research and for his contributions to the development of an ultra high-speed X-ray machine that is making possible the wartime studies of bullets as they crash through armor plate. In his new position as assistant to Dr. Harvey C. Rentschler, research director, Dr. Slack will direct experimental work on various lamp and electronic problems.

## LAFAYETTE INTRODUCES NEW TRAINING KITS

A line of kits for use in schools training students for the services has just been issued by Lafayette Radio Corporation. These range from a simple field strength meter which uses only eight essential parts, to a complete four-tube transmitter. A minimum of parts—of nationally known standard manufacture—are used for economy, simplicity, and availability should replacements be required.

Ten kits include a field strength meter, audio amplifier, vacuum-tube voltmeter, one- and two-tube regenerative receiver, signal generator, and a power supply kit. Complete receivers are provided in 5-tube superhet and a 7-tube T.R.F. designs. Kits for two transmitters are also available, one an ordinary short-wave—the other a 56-megacycle outfit.

Business-like looking chassis are provided, and in the case of the signal generator and field-strength meter, crackle-finished metal carrying cases with handles, giving the finished jobs a commercial appearance very stimulating to the student.

Each kit comes with a large schematic in the black-and-white familiar to the radio experimenter and student, all parts being drawn on an especially large scale. On the back of the schematic are top and front views which indicate the purpose of each of the holes drilled in chassis, panel or cabinet. A complete parts list is also printed on the back of the schematic.

It has been the experience of teachers that much of the time devoted to practical work in radio courses is wasted by students—many of whom may be unfamiliar with tools—doing the necessary drilling, cutting and setting up preparatory to proceeding with the radio end of the various projects. With all parts supplied to fit a chassis and panel already drilled, much of this time can be saved. Not only will this result in greater progress for students, it will encourage teachers to depend more on practical training as a means of learning radio—a system which the experience of the last two years has shown to be the only one which can produce skilled and dependable radiomen.

# Radio School Directory

TO OUR READERS—NOW IS THE TIME TO TAKE UP RADIO!

NOW, more than ever before America needs trained radio men. The Army, the Navy and the Air Force are continuously on the lookout for men who have had training in radio. Scores of war industries require radio men in various capacities throughout the country. There now is and there will be a great shortage of radio men for years to come. Reputable schools of Radio advertise to help you.

## PRE-INDUCTION RADIO COURSES

Special Summer Course for High-School Students—of Special Interest to 17-year-old boys who may be called into Military Service.

NEW CLASSES NOW STARTING  
• RADIO OPERATING • CODE  
• RADIO SERVICING

New York Y.M.C.A. Schools  
4 W. 84th Street New York City

# LEARN RADIO

600 LICENSED graduates placed in past 7 years in shipping, broadcasting, aviation, police, etc.; we also teach radio servicing and repairing; new beginners' class now forming; 60-page catalog free; oldest, largest and best equipped.

## MASS. RADIO SCHOOL

18 BOYLSTON ST., BOSTON, MASS., Est. 1899

## COMMERCIAL RADIO INSTITUTE

A radio training center for twenty-three years.

### RESIDENT COURSES ONLY

Pre-Induction, Broadcast, Service and Radio telegraphy classes now forming for August 9th. Literature upon request.

Dept. C., 38 West Biddle St., Baltimore 1, Md.

## LES Correspondence Courses in RADIO and ELECTRICAL ENGINEERING

**ELECTRICAL ENGINEERING** Get good grasp of wide electrical field. Prepare yourself, at Low Cost, for secure future. Modern, simplified, you can understand quickly.  
**RADIO ENGINEERING** Extra fine course in radio, public address, photo-electric work. Trains you to be super-service man, real vacuum tube technician. Servicemen needed badly. Diploma on completion. Tuition \$25, either course. Deferred payment plan.  
**FREE** Get copies of school catalogs, student magazines, complete details. SEND NOW!  
LINCOLN ENGINEERING SCHOOL Franklin Stn., Box 61-C53 WASHINGTON, D. C. (Formerly at Lincoln, Nebr.)

## RADIO TECHNOLOGY

RCA Institute offers an intensive two-year course of high standard embracing all phases of Radio and Television. Practical training with modern equipment. Also shorter specialized courses in Commercial Radio Operating, Radio and Television Servicing, and Aviation Communications. For Free Catalog write Dept. RC-43.

### BCA INSTITUTES, Inc.

A Radio Corporation of America Service  
75 VARICK STREET NEW YORK

## ... Here's How You Can Qualify for a BETTER RADIO JOB!

... CREI technical training is preparing others for good-paying radio jobs—WHY NOT YOU?

Are you finding yourself in a routine job—a job that any other man can handle just as well as you? Today, radio JOBS are many—but radio CAREERS are few! Now is the opportune time for you to equip yourself with the necessary technical training to qualify for an important engineering position with a sound future.

NOW when industry needs men, is the time for you to investigate radio career training. Your radio experience backed by modern CREI technical training will equip you to share in the good-paying jobs that await trained men... and to make good in the important positions that lead to security and happiness!

WRITE TODAY! If you are a professional or amateur radio-man and want to make more money—let us prove to you we have something you need to qualify for the better job opportunities that can be yours. To help us intelligently answer your inquiry—please state briefly your education, radio experience and present position.



## CAPITOL RADIO ENGINEERING INSTITUTE

Dept. RC-7, 3224 16th St., N.W., Washington 10, D.C.

## RADIO-TELEVISION VITAL to War Effort

Enroll now with new groups. Opportunity under war conditions and real future in peacetime.

RADIO-TELEVISION INSTITUTE  
Dept. R. C.  
480 Lexington Ave., New York, N. Y.

### RADIO OPERATORS WANTED

Be a "key" man. Learn how to send and receive messages in code by telegraph and radio. Army, Navy and Commerce needs thousands of men. Good pay, adventure, interesting work. Learn at home quickly through famous Candler System. Write for FREE BOOK.  
**CANDLER SYSTEM CO.**  
Dept. 3-N, Box 928  
Denver 1, Colo. U.S.A.

## RADAR MAY HAVE GREAT PEACETIME IMPORTANCE

Radar as a weapon of war has received much recent publicity. What has been overlooked by many is its potential peace-time importance in the post-war world. The same device which gives warning of approaching planes may also be used on ships to prevent collisions, or even, conceivably, on express trains!

One of the first applications of a Radar-like device was the absolute altimeter introduced in 1938. This indicated the height of an airplane over the nearest obstruction below it, instead of the height above sea-level given by the ordinary altimeter. This latter device might indicate a safe height while the plane was rushing into a mountain or skyscraper.

The absolute altimeter operated by sending radio waves from a small transmitter in one wing straight down. The waves, reflected from the earth, were picked up by a receiver in the other wing, and the distance from the point which reflected them back was indicated on a dial.

This device was never brought to the point where it came into universal use. With the improvements offered by Radar, however, there is little doubt that vastly improved altimeters of this type will find a place in every commercial plane.

# TO PRESERVE THE FOUR FREEDOMS!

... freedoms that are uppermost in the heart of every American. Workers in industry have toiled unceasingly to build peak production to enable their country to be the world's best equipped fighting forces to protect these freedoms.

The Hallicrafters employees have twice been cited by their country for excellence in production ... once with the Army-Navy "E" Burgee ... and now the addition of a star to this Burgee for continued excellence in producing communications equipment so vitally needed by our boys on all fronts.

This new honor will serve as an additional incentive to greater production.

**BUY  
MORE  
BONDS!**



**hallicrafters**  
CHICAGO, U.S.A.

IN RECOGNITION  
OF CONTINUED EXCELLENCE  
IN PRODUCTION A STAR  
HAS BEEN ADDED TO

**hallicrafters**  
*Army-Navy*  
BURGEE

# Audels -MANS RADIO GUIDE

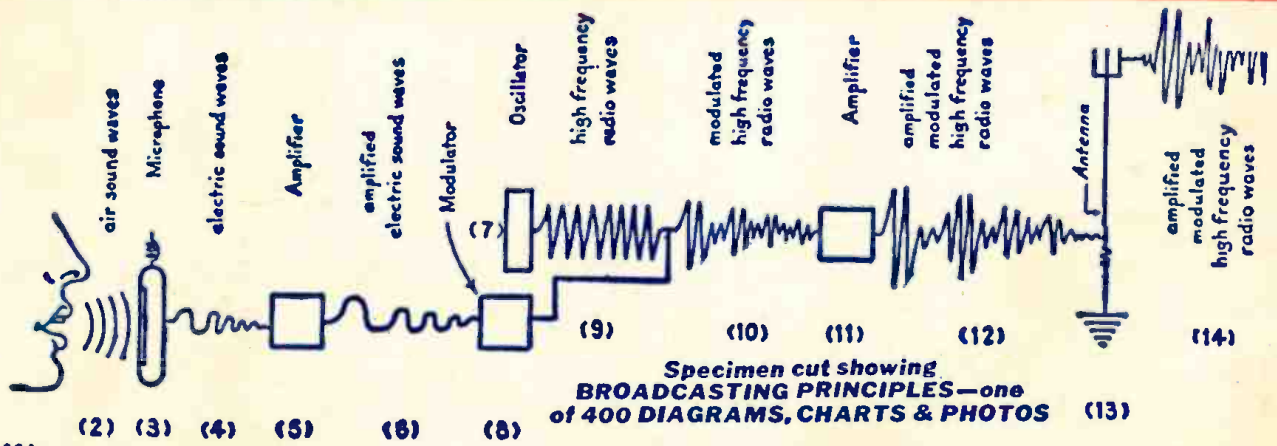

(1)  
**QUESTIONS  
AND  
ANSWERS**

**1001  
FACTS**



## THE KEY TO PRACTICAL RADIO INFORMATION

Including Frequency Modulation—Television, etc.  
Inside Information for Aviation, Marine, Commercial Operators  
and Technicians, Servicemen and Students

**772 PAGES, 400 DIAGRAMS, CHARTS & PHOTOS**

This well organized reading course in Radio is especially suitable for home study and as a ready reference guide to help you learn the inside facts about radio. The amount of mathematics required for a successful study of this book is fully covered as the various chapters include numerous practical radio problems, carefully worked out, step by step, to their final solution. The contents are PROGRESSIVELY ARRANGED AND CAREFULLY INDEXED.

### LATE DATA—EASY TO READ AND UNDERSTAND

Gives Authentic Principles and Practices in Construction, Operation, Service & Repairs. Covers clearly and concisely Radio fundamentals—Ohm's Law—Physics of sound as related to radio science—Measuring instruments—Power supply—Resistors—Inductors—Condensers—Transformers and examples—Broadcasting stations—Radio Telephony—Receivers—Diagrams—Construction—Control systems—Loudspeakers—Antennas—Auto Radio—Phonograph pickups—Public Address Systems—Aircraft & Marine Radio—Radio Compass—Beacons—Automatic Radio Alarms—Short Wave—Coil Calculations—Testing—Cathode ray oscillographs—Static Elimination—Trouble Pointers—Underwriter's standards—Units & tables. REVIEW QUESTIONS—Ready Reference Index.

**HIGHLY ENDORSED—ASK TO SEE IT ON 7 DAYS' FREE TRIAL**

**MAIL COUPON TODAY**

**THEO. AUDEL & CO., Publishers, 49 West 23rd St., New York**  
Mail AUDELS NEW RADIOMAN'S GUIDE for free examination. If O.K. I will send you \$1 in 7 days; then remit \$1 monthly until \$4 is paid. Otherwise I will return it.

Name.....  
Address.....  
Occupation.....  
Reference.....

**\$4 COMPLETE  
PAY \$1 A  
ONLY 1 MO.**



# ADV Plans, LLC

## Copyright Notice:

The entire contents of this CD/DVD are copyright 2014 by ADV Plans, LLC. All Rights Reserved.

Reproduction or distribution of this disk, either free or for a fee is strictly prohibited. We actively monitor and remove listings on eBay thru Vero.

You are free to copy or use individual images in your own projects, magazines, brochures or other school projects.

Only the sellers listed here are authorized distributors of this collection:  
[www.theclassicarchives.com/authorizedsuppliers](http://www.theclassicarchives.com/authorizedsuppliers)

Please view our other products at  
[www.theclassicarchives.com](http://www.theclassicarchives.com),  
or our ebay stores:

[TheClassicArchives](#)  
[ADVPlans](#)  
[SuperShedPlans](#)

